



## Advanced handheld label printing

**BMP61 Label Printer &  
BradyPrinter M611 Mobile Label Printer**

# About BRADY



Once you have worked with BRADY, our name will stick with you, (just like our labels) because BRADY is one of the world's leading labelling and identification specialists.

## Innovative

At BRADY we continue to improve. We have many customers from all industries, and we strive to be ahead of their needs by continuing to invest in research for even more performant solutions. By developing more user-friendly and efficient concepts, we give our thousands of customers the best in the market.

## Strength

At BRADY, we believe our biggest strength is the wide range of identification and safety solutions we can offer our customers, whether it's labelling the smallest component or complete signage for an entire warehouse. We're also proud to offer many products and services - from printers, scanners and software to service contracts and on-site training - that compliment any identification job. And don't forget, our wide network of expert distributors can always offer you a tailor-made solution to meet your specific requirements.

## Trust

For over a hundred years, BRADY has been connected with quality, trust and stability. We demand the best for your products and services, because we know, better than anyone, the importance of good and reliable identification. Identification looks like a small detail, but every professional knows that this kind of detail is crucial to any business.

## Inform

We also have specialised dealers in your region, who can answer all your identification, safety and labelling questions, specific to your activity. They will be happy to provide you with all kinds of options and solutions with no obligation.

Microsoft is a trademark of Microsoft Corporation, Bluetooth is a trademark of Bluetooth Sig, Inc., Android is a trademark of Google Inc.



Brady products are sold on the condition that the purchaser will test them in actual use and determine for himself/herself their suitability to his/her intended purpose. Brady warrants to the purchaser that Brady products are free from defects in material and workmanship but limits its obligation under this warranty to the replacement of the product which has been shown to Brady's satisfaction to have been defective at the time of its purchase.

The warranty does not extend to any persons who have acquired the product from the purchaser. It is in lieu of any other warranty, including every warranty of sale-ability, marketability or suitability for the intended purpose, and is also in lieu of any other obligation or liability on the part of Brady.

Under no circumstances will Brady be liable for losses, damage, costs or subsequent damage of whatever nature which may arise in connection with the use of, or inability to use, Brady's products.

# BMP61 Label Printer & BradyPrinter M611 Mobile Label Printer

## The Brady Advantage

When it comes to identification, safety and compliance, there's a clear advantage to working with Brady. We put our customers first in everything we do.

Our goal is to give you an unrivalled customer experience. We are relentlessly committed to performance and excellence - in our products, services and people.

Our products and solutions perform in ways that others simply can't match. Our people perform in ways that regularly exceed your expectations. And our focus and discipline work toward solid, long-term performance for our customers.

In short, Brady is the company you trust when performance matters most.

**Learn more about the Brady Advantage at: [www.bradyeurope.com](http://www.bradyeurope.com)**

## Contents

4	BMP61 introduction
5	BradyPrinter M611 introduction
6	BMP61 at a glance
7	BradyPrinter M611 at a glance
8	Applications
10	Advantages of labelling
11	What is a professional label?
12	Labels
13	Ribbons
14	Performance attributes
15	Font sizes & symbol library
16	Electrical, voice/datacom identification
33	General & industrial identification
37	Electronics identification
41	Laboratory identification
49	Master material index
54	BMP61 software
55	BradyPrinter M611 software
56	BMP61 Label Printer specifications
57	BradyPrinter M611 specifications
58	BMP61 Printer, kits and accessories
59	BradyPrinter M611 Printer and accessories



**BMP61**  
LABEL PRINTER



**BradyPrinter M611**  
MOBILE LABEL PRINTER

## Performance that matches your own

Electricians, data centre technicians and panel builders can rely on the BMP61 Label Printer to identify wires, cables and components quickly and efficiently.

The BMP61 Label Printer will be your trusted identification companion of choice, all day, every day, for years to come.



## Rugged & reliable

- Drop-tested and equipped with moulded rubber bumpers
- Large material loading bay for fast label material swaps
- Smart-cell cartridge technology enables auto-calibration
- Large colour touchscreen with on-screen indicators: easily check which label cartridge is installed and how many labels you have left. Quickly review your label on the display before printing to avoid mistakes
- 33.8 mm/second print speed: don't wait on the label you need
- Rechargeable NiMH-battery for increased autonomy
- 2 year warranty



## High-performance materials & excellent print quality

- 600 label materials + custom labels: don't use a half-baked solution. Choose from 600 label material (sleeves, self-lams and more) and ink ribbon combinations, or ask Brady to develop custom labels to answer your needs!
- Handles die-cut, continuous and custom labels up to 50.80 mm - also in bulk format
- Intuitive typing thanks to the AZERTY/QWERTY/QWERTZ/ CYRILLIC keyboards
- 300 dpi print quality



## Data management versatility

- USB list feature: read spreadsheets directly from external USB-memory and integrate the data in your labels ready for printing
- Wifi-version available – compatible with mobile apps: create or load label templates with your smartphone and send them to your printer
- USB 2.0 ports (Type A & B) to copy large lists of label designs
- Works with LabelMark labelling software, Brady mobile apps and Brady Workstation

**With the BMP61 Label Printer you will be able to flawlessly finish a great many identification tasks.**



**BMP61**  
LABEL PRINTER

[Scan or click the QR-code](#)



## Join the evolution of smarter identification

The BradyPrinter M611 Mobile Printer announces a new chapter in the ongoing evolution of identification. Easily design the most complex labels in the field using only your smartphone and Brady's free Express app before printing on reliable, industrial grade label materials with the M611 Mobile Printer.

 For more information on the Express app, see page 55.

## Design any complex label in the field with a phone

With our Express app installed, you can easily design complex labels with 1D and 2D codes and barcodes, serialise, use an extensive image library, include text, a time stamp and even data from the cloud. The Express app offers the most comprehensive label design capabilities available for any smartphone and includes design wizards to quickly create specific identification labels.



## Access from anywhere

Label designs can be sent to the BradyPrinter M611 from the Express app on a smartphone via wifi or Bluetooth for immediate printing. They can also be sent to, or received from computers in the office so you don't need to design a label from scratch on every occasion. Simply access existing designs, edit and print to bridge the gap between the office and the field. Labels designed with any app from the Brady Workstation app platform are compatible with the Express app delivered with the BradyPrinter M611.



## Print reliable labels

The BradyPrinter M611 Mobile Printer is compatible with our wide range of reliable, industrial grade label materials. Able to resist extreme temperatures, fire, chemicals, solvents, fuels, moisture or dirt, these materials are designed to stay attached and remain legible in challenging conditions. They are available in professional label types including wire wraps, self-laminating labels, flag labels, tags and various component labels including raised profile labels with nameplate quality.

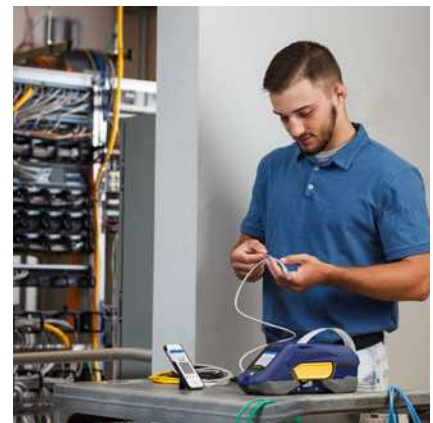

  **BradyPrinter M611**  
MOBILE LABEL PRINTER  
[Scan or click the QR-code](#) 

Large colour touchscreen with indicators:

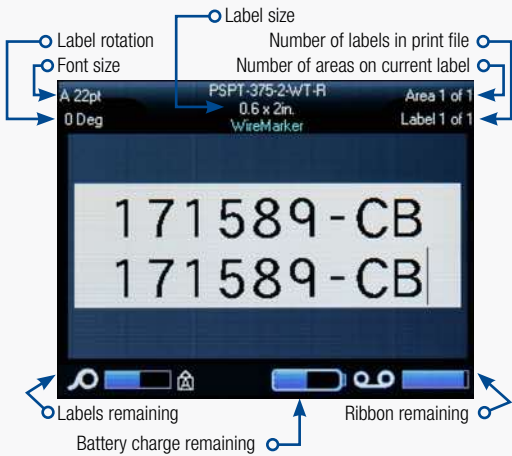

Large cover opening & bay for easy pop-in and out material loading

Manual cutter

Crisp print with 300dpi print head

Die-cut, continuous & custom label supplies up to 50.80 mm wide

Optional WIFI (factory-installed, on certain models only)

Auto label calibration with Smart-Cell technology

Rechargeable NiMh battery or AC power (included)

Carrying strap handle

Moulded rubber bumpers

AZERTY/QWERTY/QWERTZ/CYRILLIC style keypad

## 2 YEAR WARRANTY



### Brady Workstation Express Labels App

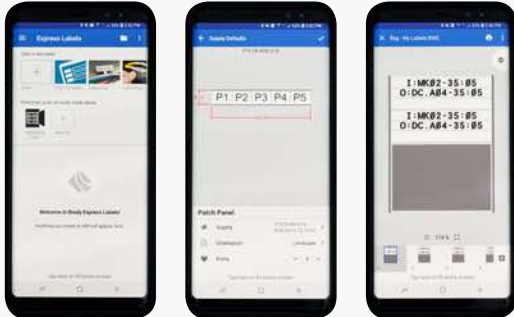

Easy material loading with bulk-size roll option

Rechargeable Li-Ion internal battery and AC power (included)

Die-cut, continuous & custom label supplies up to 50.80 mm wide

Auto cutter

USB cord and USB ports 2.0 (types A & B)

Crisp print with 300dpi print head

Rugged rubber bumpers

Automatic label formatting with smart-cell technology

73x55mm colour touchscreen display

Wi-Fi and Bluetooth

**2 YEAR WARRANTY**

## Electrical, voice/datacom identification

**Wire & cable marking** for twisted pair data cables (UTP, FTP...), fibre optic cables, conductors, computer wires, electrical installation wires & cables, power & ground cables, energy cables...



Flags



Tags



Self-lams



Sleeves



Wrap-around labels

**Component marking** for patch panels, control panels, punch blocks, terminal blocks, breaker boxes, face-plates...



Punch block & patch panel labels

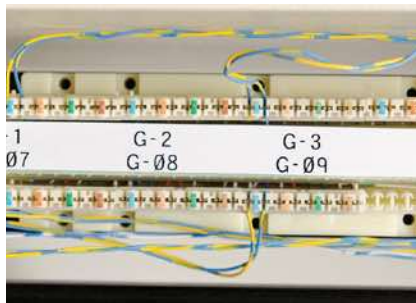

Terminal block labels



Raised panels

## General & industrial identification

**Asset & component marking** to be used on all kind of surfaces (smooth, rough, textured, low energy...).



Rating & name plate labels



Overlaminated labels



Pre-printed labels

## Electronics identification

**Circuit board marking** for printed circuit board identification (also static dissipative), PCB SMT – Top/Bottom...

**Component marking** for relays, solenoids, through hole – bottom, through hole – top...



Electronic component labels



High resistant labels



Security identification labels

## Laboratory identification

**Specimen tracking identification** for sample tracking within histology labs: utilize barcode technology to prevent misdiagnosis.



Straws & rods



Vial & tube labels



Conical & large tube labels

**Specimen process marking** supporting microscopic analysis of cells and tissues within pathology and clinical labs.



Centrifuge, Eppendorf & PCR labels



Slide labels

**Specimen storage identification** supporting specimen collection and handling such as blood samples, cryo-samples etc.



Cryo labels

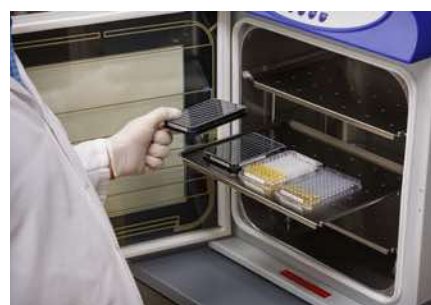

Well plate labels

**Lean lab identification** for general supplies marking.



Bottles, flasks & dishes

### Ever lost time figuring out where each wire goes?

Durable professional labels that remain legible and stay attached in harsh conditions are extremely important to keep power, network, voice and data cables and components organised and running effectively.

### Professional identification on wires, cables and components enables you to:

- immediately recognise what needs checking during troubleshooting
- clearly mark parts for upcoming maintenance upgrades
- trace history, lifespan and supplier
- add safety warnings or precautions

Ask yourself how much time or money you lose while trying to trace an unidentified faulty cable, wire or component.

Ask yourself how fast pressure builds when machinery, production lines, servers and services are impacted.

### This is when professional labelling pays off big time.



## The combination of label liner, adhesive, substrate and topcoat provide a professional label's features, resistances, capabilities and durability.

- 1 The topcoat gives the label its colour and finish, receives the print, and increases resistance against weathering, flames, chemicals or heat.
- 2 The substrate gives the label its form and provides tensile properties such as strength and flexibility and physical properties such as chemical and temperature resistance.
- 3 The adhesive attaches the label to a chosen surface type and ensures resistance against a set of environmental contexts.
- 4 The label liner is a very thin carrier that releases the self-adhesive label.

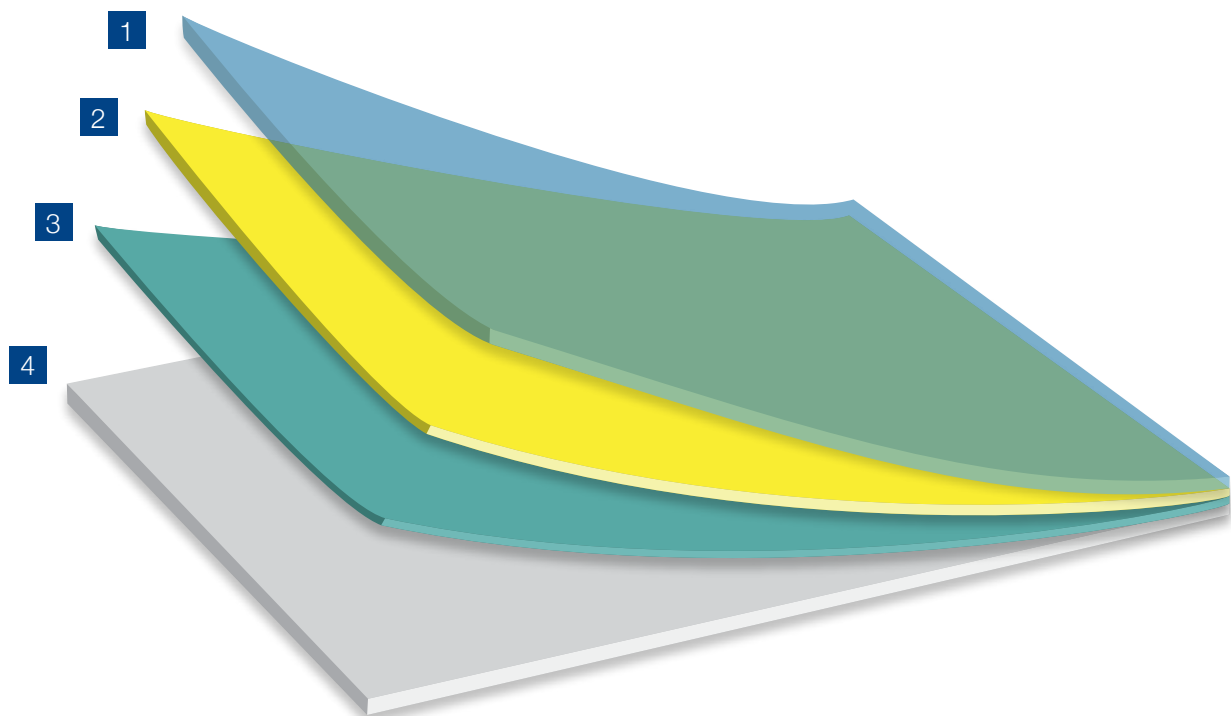

### Which label suits your needs best?

Request your Electrical, Tele- & Datacom Identification guide book to help you choose the optimal Brady label material for your application at:

[www.bradyeurope.com/cableID](http://www.bradyeurope.com/cableID).

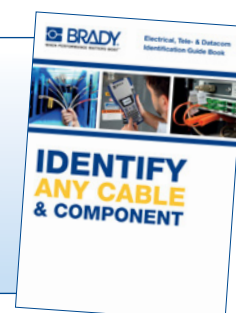

We continuously try to improve & extend our label material offering, therefore make sure to check for firmware upgrades regularly, in order to make sure you always have access to the newest materials.

Material	
B-109	Polyethylene Tag
B-145	Polyethylene Tag
B-321	Heat-shrink Polyolefin Sleeve
B-342	Heat-shrink Polyolefin Sleeve
B-345	High Temperature Heat-shrink Polyvinylidene Fluoride Sleeve
B-362	Tamper-resistant Metallised Vinyl
B-390	Rigid Insert
B-403	Paper
B-412	Polypropylene Tag
B-422	Polyester
B-422/B-966B	Polyester
B-423	Polyester
B-424	Paper
B-424/B-966B	Paper with Polyester Overlamine
B-425	Polypropylene
B-427	Self-laminating Vinyl
B-428	Metallised Polyester
B-428/B-966	Metallised Polyester with Polyester Overlamine
B-430	Polyester
B-432	Polyester
B-435	Metallised Polyester
B-437	Polyvinylfluoride
B-439	Vinyl
B-459	Polyester
B-461	Self-laminating Polyester
B-473	Static Dissipative Polyester
B-483	Polyester

Material	
B-486	Metallised Polyester
B-488	Polyester
B-489	Polyester
B-490	Freezerbondz™ Polyester
B-498	Vinyl Cloth
B-499	Nylon Cloth
B-642	Polyvinylfluoride
B-717	Polyimide
B-718	Polyimide
B-719	Polyimide
B-724	Polyimide
B-727	Polyimide
B-7351	Tamper-resistant Vinyl
B-7425	Polypropylene
B-7546	Tamper-evident Polyester
B-7551	Polyester
B-7576	Tamper-evident Metallised Polyester
B-7593	Polyethylene Foam Laminate Polyester
B-7597	Polyethylene Tag
B-7598	Polyester Tag
B-7599	Polyethylene Tag
B-7643	Thermoplastic Polyether Polyurethane
B-7644	Polypropylene Tag with Polyester Overlamine
B-7645	Polypropylene Tag with Polyester Overlamine
B-7696	Vinyl Tag
B-7697	Polyester Tag

## Bulk packaging for high volume printing

Bulk label printing requires the media feeder and smart cell spool which are included in the bulk label material packaging.



### Get a custom label that perfectly fits your needs!

- custom shapes and dimensions
- custom colours
- custom materials with specific resistance
- custom print or layout

[www.bradyeurope.com/customlabels](http://www.bradyeurope.com/customlabels)

All materials in the printers work with a series of M61 ribbons that easily fit into the printers. It is recommended to insert the ribbon before loading the consumable.



Order Reference	Colour	Roll Width (mm)	Roll Length (m)	Notes / Details
M61-R4310	Black	50.80	22.80	BMP61/M611 R4300 Series : chemical, environmental and smear resistant black ribbon
M61-R4410-BL	Blue	50.80	22.80	BMP61/M611 R4400 Series : high heat, scratch and solvent resistant blue ribbon
M61-R4410-RD	Red	50.80	22.80	BMP61/M611 R4400 Series : high heat, scratch and solvent resistant red ribbon
M61-R4410-WT	White	50.80	22.80	BMP61/M611 R4400 Series : high heat, scratch and solvent resistant white ribbon
M61-R6010	Black	50.80	22.80	BMP61/M611 R6000 Series : high heat, scratch and solvent resistant black ribbon
M61-R6210	Black	50.80	22.80	BMP61/M611 R6200 Series : chemical, heat, scratch and smear resistant black ribbon
M61-R6410	Black	50.80	22.80	BMP61/M611 R6400 Series : abrasion and chemical resistant black ribbon
M61-R6610	Black	50.80	22.80	BMP61/M611 R6600 Series : friction and solvent resistant black ribbon
M61-R6710-WT	White	50.80	22.80	BMP61/M611 R6700 Series : chemical resistant white ribbon
M61-R6810-WT	White	50.80	22.80	BMP61/M611 R6800 Series : scratch, smudge and solvent resistant white ribbon

## Smart-Cell Technology



With smart-cell technology built into label rolls and ribbons, the printers are able to automatically format the label and place objects so that there is no guess work on your part. If the label material & ribbon are not compatible, the screen will show an error message.



## Product performance icons

Brady's implementation of a series of attribute icons provides customers with at-a-glance information on performance attributes for each of the label materials. Watch for these icons to help you easily identify product performance features that fit your needs.

















### Want more information?







Complete technical data sheets are available at [www.bradyeurope.com/tds](http://www.bradyeurope.com/tds) for Brady's entire range of reliable identification labels. They can easily be found by entering a specific label's B-number. Relevant B-numbers for your printer are listed on page 49 to 53 in this brochure.



## Material brands & attributes

						
	WorkHorse labels	MetaLabel series	ToughBond series	Defender series	CleanLift series	UltraTemp series
 Abrasion resistance	✓	✓	✓	✓	✓	✓
 Electrostatic dissipative	✓	-	-	-	-	✓
 Fuel/oil resistance	✓	✓	✓	✓	✓	✓
 High heat resistance	✓	✓	✓	✓	✓	✓
 Low temperature resistance	✓	✓	✓	✓	✓	✓
 Removable	-	-	-	-	✓	-
 Solvent/chemical resistance	✓	✓	✓	✓	✓	✓
 Tamper-indicating	-	-	-	✓	-	-
 Ultra-aggressive adhesive	-	✓	✓	-	-	-

## Recommended material applications

						
	WorkHorse labels	MetaLabel series	ToughBond series	Defender series	CleanLift series	UltraTemp series
UL / CSA	✓	✓	✓	✓	✓	✓
Component / equipment identification	✓	✓	✓	✓	✓	-
Barcode / data-coding	✓	✓	✓	-	✓	✓
Inventory tracking	✓	-	✓	-	✓	-
Asset tracking	✓	✓	✓	✓	✓	✓
Rating plate	✓	✓	✓	-	✓	-
General identification	✓	-	✓	-	✓	-
Over-laminate	✓	-	✓	-	✓	-
Ultra-aggressive adhesive	-	✓	✓	-	-	-
Circuit board identification / high temperature	✓	-	-	-	✓	✓
Tamper-indicating	-	-	-	✓	-	-
DoD UID*	-	-	✓	-	-	✓

\*The Department of Defense Unique Identification program (DoD UID) is the asset tracking method used to manage inventory in the defense supply chain.

### Variable font sizes

Font sizes range from 4 to 174 point. The maximum font size available depends on factors such as label size, number of characters, number of lines, as well as font sizes in other lines.

Point Size	Print Sample
4	ABC 12345
6	ABC 12345
7	ABC 12345
9	ABC 12345
10	ABC 12345
14	ABC 12345
16	ABC 12345
20	ABC 12345
26	ABC 12345
32	ABC 12345
40	ABC 12345
45	ABC 1234
51	ABC 123
55	ABC 123
60	ABC 123
65	ABC 12
70	ABC 12
76	AB 12
102	AB 12



The information on this page is BMP61 specific. For the M611, fonts and symbols are within the Express app. **For more information about the Express app, see page 55.**

### Barcode types



- Code 39 and Code 128
- Other barcodes supported

### Symbol library

- Standard electrical and datacom symbols
- Over 500 built in graphics
- Built in time/date stamp

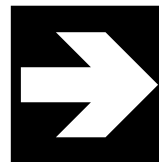

Arrows

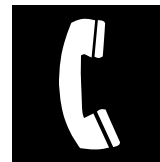

Datacom



Electrical



Exit



Fire

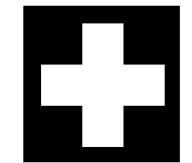

First aid

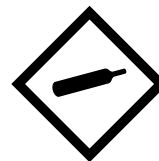

GHS

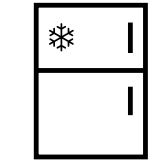

Home electrical



International



Mandatory



Packaging



Prohibition



Public info

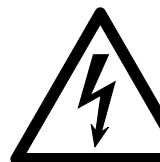

Warning



WHMIS

...and many more



## Wire & cable marking

### PermaSleeve Heat-shrink sleeve markers

- These heat-shrink sleeves are the ultimate in marker identification, protection, durability and aesthetic appearance.
- Fast shrink rate saves time and costs during installation.

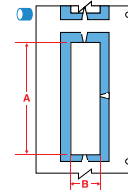
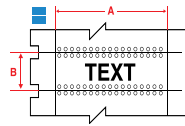
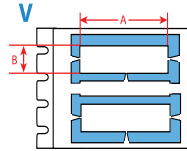

Diagram	Order Reference	Shrink Ratio	Colour	Sleeve Width A (mm)	Sleeve Height B (mm)	Vertical Repeat (mm)	Min. Wire Diameter (mm)	Max. Wire Diameter (mm)	Sleeves per roll	Printer Ribbon Series	Printer Compatibility
<b>B-321: Heat-shrink Polyolefin Sleeve</b>											
	PTS-0.45-350-321	2:1	White	11.43	8.89	8.89	1.91	4.06	500	M61-R6210	M611, BMP61, BMP71
	PTS-0.95-350-321	2:1	White	24.13	8.89	8.89	1.91	4.06	500	M61-R6210	M611, BMP61, BMP71
	PTS-1.90-350-321	2:1	White	48.26	8.89	8.89	1.91	4.06	500	M61-R6210	M611, BMP61, BMP71
	PTS-0.45-500-321	2:1	White	11.43	12.70	12.70	4.06	5.97	500	M61-R6210	M611, BMP61, BMP71
	PTS-0.95-500-321	2:1	White	24.13	12.70	12.70	4.06	5.97	500	M61-R6210	M611, BMP61, BMP71
	PTS-1.90-500-321	2:1	White	48.26	12.70	12.70	4.06	5.97	500	M61-R6210	M611, BMP61, BMP71
	PTS-0.95-750-321	2:1	White	24.13	19.05	19.05	8.51	9.91	250	M61-R6210	M611, BMP61, BMP71
	PTS-1.90-750-321	2:1	White	48.26	19.05	19.05	8.51	9.91	250	M61-R6210	M611, BMP61, BMP71
	PTS-0.95-1000-321	2:1	White	24.13	25.40	25.40	9.53	13.72	250	M61-R6210	M611, BMP61, BMP71
	PTS-1.90-1000-321	2:1	White	48.26	25.40	25.40	9.53	13.72	250	M61-R6210	M611, BMP61, BMP71
<b>B-342: Heat-shrink Polyolefin Sleeve</b>											
	BM71-94-1-342-2	3:1	White	12.70	4.60	-	0.58	2.03	5000	M61-R4300	M611, BMP61, BMP71
	BM71-94-175-342-2	3:1	White	22.22	4.60	-	0.58	2.03	5000	M61-R4300	M611, BMP61, BMP71
	BM71-94-1-342	3:1	White	25.78	4.60	-	0.58	2.03	2500	M61-R4300	M611, BMP61, BMP71
	BM71-94-1-342YL	3:1	Yellow	25.78	4.60	-	0.58	2.03	2500	M61-R4300	M611, BMP61, BMP71
	BM71-94-175-342	3:1	White	44.83	4.60	-	0.58	2.03	2500	M61-R4300	M611, BMP61, BMP71
	BM71-94-175-342YL	3:1	Yellow	44.83	4.60	-	0.58	2.03	2500	M61-R4300	M611, BMP61, BMP71
	PSPT-094-1-WT-2	3:1	White	12.89	4.62	12.70	0.58	2.03	200	M61-R4310	M611, BMP61, BMP71
	PSPT-094-1-BL	3:1	Blue	25.78	4.62	12.70	0.58	2.03	100	M61-R4310	M611, BMP61, BMP71
	PSPT-094-1-GR	3:1	Green	25.78	4.62	12.70	0.58	2.03	100	M61-R4310	M611, BMP61, BMP71
	PSPT-094-1-OR	3:1	Orange	25.78	4.62	12.70	0.58	2.03	100	M61-R4310	M611, BMP61, BMP71
	PSPT-094-1-RD	3:1	Red	25.78	4.62	12.70	0.58	2.03	100	M61-R4310	M611, BMP61, BMP71
	PSPT-094-1-WT	3:1	White	25.78	4.62	12.70	0.58	2.03	100	M61-R4310	M611, BMP61, BMP71
	PSPT-094-1-YL	3:1	Yellow	25.78	4.62	12.70	0.58	2.03	100	M61-R4310	M611, BMP61, BMP71
	PSPT-094-175-BL	3:1	Blue	44.83	4.62	12.70	0.58	2.03	100	M61-R4310	M611, BMP61, BMP71
	PSPT-094-175-OR	3:1	Orange	44.83	4.62	12.70	0.58	2.03	100	M61-R4310	M611, BMP61, BMP71
	PSPT-094-175-WT	3:1	White	44.83	4.62	12.70	0.58	2.03	100	M61-R4310	M611, BMP61, BMP71
	PSPT-094-175-YL	3:1	Yellow	44.83	4.62	12.70	0.58	2.03	100	M61-R4310	M611, BMP61, BMP71
	PSPT-094-2-BK-R	3:1	Black	50.80	4.62	12.70	0.58	2.03	70	M61-R6710-WT	M611, BMP61, BMP71
	PSPT-094-2-WT-R	3:1	White	50.80	4.62	12.70	0.58	2.03	70	M61-R4310	M611, BMP61, BMP71
	PSPT-094-2-YL-R	3:1	Yellow	50.80	4.62	12.70	0.58	2.03	70	M61-R4310	M611, BMP61, BMP71
	PSPT-125-1-WT-2	3:1	White	12.89	5.96	19.05	1.17	2.79	200	M61-R4310	M611, BMP61, BMP71
	PSPT-125-175-WT-3	3:1	White	14.94	5.96	19.05	1.17	2.79	300	M61-R4310	M611, BMP61, BMP71
	PSPT-125-1-BK	3:1	Black	25.78	5.96	19.05	1.17	2.79	100	M61-R6710-WT	M611, BMP61, BMP71
	PSPT-125-1-BL	3:1	Blue	25.78	5.96	19.05	1.17	2.79	100	M61-R4310	M611, BMP61, BMP71
	PSPT-125-1-RD	3:1	Red	25.78	5.96	19.05	1.17	2.79	100	M61-R4310	M611, BMP61, BMP71
	PSPT-125-1-WT	3:1	White	25.78	5.96	19.05	1.17	2.79	100	M61-R4310	M611, BMP61, BMP71
	PSPT-125-1-YL	3:1	Yellow	25.78	5.96	19.05	1.17	2.79	100	M61-R4310	M611, BMP61, BMP71
	PSPT-125-175-GR	3:1	Green	44.83	5.96	19.05	1.17	2.79	100	M61-R4310	M611, BMP61, BMP71
	PSPT-125-175-OR	3:1	Orange	44.83	5.96	19.05	1.17	2.79	100	M61-R4310	M611, BMP61, BMP71
	PSPT-125-175-WT	3:1	White	44.83	5.96	19.05	1.17	2.79	100	M61-R4310	M611, BMP61, BMP71
	PSPT-125-175-YL	3:1	Yellow	44.83	5.96	19.05	1.17	2.79	100	M61-R4310	M611, BMP61, BMP71
	PSPT-125-2-BK-R	3:1	Black	50.80	5.96	19.05	1.17	2.79	70	M61-R6710-WT	M611, BMP61, BMP71
	PSPT-125-2-WT-R	3:1	White	50.80	5.96	19.05	1.17	2.79	70	M61-R4310	M611, BMP61, BMP71
	PSPT-125-2-YL-R	3:1	Yellow	50.80	5.96	19.05	1.17	2.79	70	M61-R4310	M611, BMP61, BMP71
	BM71-125-1-342-2	3:1	White	12.70	6.00	-	1.17	2.79	2000	M61-R4300	M611, BMP61, BMP71
	BM71-125-175-342-3	3:1	White	14.94	6.00	-	1.17	2.79	3000	M61-R4300	M611, BMP61, BMP71
	BM71-125-175-342-2	3:1	White	22.22	6.00	-	1.17	2.79	2000	M61-R4300	M611, BMP61, BMP71
	BM71-125-1-342	3:1	White	25.78	6.00	-	1.17	2.79	1000	M61-R4300	M611, BMP61, BMP71
	BM71-125-1-342-YL	3:1	Yellow	25.78	6.00	-	1.17	2.79	1000	M61-R4300	M611, BMP61, BMP71
	BM71-125-175-342	3:1	White	44.83	6.00	-	1.17	2.79	1000	M61-R4300	M611, BMP61, BMP71
	BM71-125-175-342YL	3:1	Yellow	44.83	6.00	-	1.17	2.79	1000	M61-R4300	M611, BMP61, BMP71
	PSPT-187-1-WT-3	3:1	White	8.59	8.50	19.05	1.57	3.81	300	M61-R4310	M611, BMP61, BMP71
	BM71-187-175-342-4	3:1	White	11.21	8.50	-	1.57	3.81	4000	M61-R4300	M611, BMP61, BMP71
	PSPT-187-175-WT-4	3:1	White	11.21	8.50	19.05	1.57	3.81	400	M61-R4310	M611, BMP61, BMP71
	BM71-187-1-342-2	3:1	White	12.70	8.50	-	1.57	3.81	2000	M61-R4300	M611, BMP61, BMP71

Order references beginning with "B" indicate bulk rolls. Order reference ending with "R" indicate that the sleeve is rotated on the liner.

>>

## Wire & cable marking

### PermaSleeve Heat-shrink sleeve markers (continued)

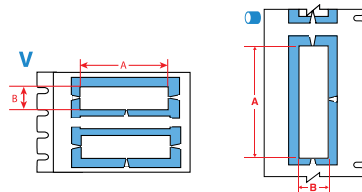

Diagram	Order Reference	Shrink Ratio	Colour	Sleeve Width A (mm)	Sleeve Height B (mm)	Vertical Repeat (mm)	Min. Wire Diameter (mm)	Max. Wire Diameter (mm)	Sleeves per roll	Printer Ribbon Series	Printer Compatibility
V	PSPT-187-1-WT-2	3:1	White	12.89	8.50	19.05	1.57	3.81	200	M61-R4310	M611, BMP61, BMP71
V	BM71-187-175-342-3	3:1	White	14.94	8.50	-	1.57	3.81	3000	M61-R4300	M611, BMP61, BMP71
V	PSPT-187-175-WT-3	3:1	White	14.94	8.50	19.05	1.57	3.81	300	M61-R4310	M611, BMP61, BMP71
V	BM71-187-175-342-2	3:1	White	22.22	8.50	-	1.57	3.81	2000	M61-R4300	M611, BMP61, BMP71
V	PSPT-187-175-WT-2	3:1	White	22.42	8.50	19.05	1.57	3.81	200	M61-R4310	M611, BMP61, BMP71
V	PSPT-187-1-BK	3:1	Black	25.78	8.50	19.05	1.57	3.81	100	M61-R6710-WT	M611, BMP61, BMP71
V	PSPT-187-1-BL	3:1	Blue	25.78	8.50	19.05	1.57	3.81	100	M61-R4310	M611, BMP61, BMP71
V	PSPT-187-1-GR	3:1	Green	25.78	8.50	19.05	1.57	3.81	100	M61-R4310	M611, BMP61, BMP71
V	PSPT-187-1-RD	3:1	Red	25.78	8.50	19.05	1.57	3.81	100	M61-R4310	M611, BMP61, BMP71
V	PSPT-187-1-VT	3:1	Violet	25.78	8.50	19.05	1.57	3.81	100	M61-R4310	M611, BMP61, BMP71
V	PSPT-187-1-WT	3:1	White	25.78	8.50	19.05	1.57	3.81	100	M61-R4310	M611, BMP61, BMP71
V	BM71-187-1-342	3:1	White	25.78	8.50	-	1.57	3.81	1000	M61-R4300	M611, BMP61, BMP71
V	PSPT-187-1-YL	3:1	Yellow	25.78	8.50	19.05	1.57	3.81	100	M61-R4310	M611, BMP61, BMP71
V	BM71-187-1-342-YL	3:1	Yellow	25.78	8.50	-	1.57	3.81	1000	M61-R4300	M611, BMP61, BMP71
V	PSPT-187-175-BK	3:1	Black	44.83	8.50	19.05	1.57	3.81	100	M61-R6710-WT	M611, BMP61, BMP71
V	PSPT-187-175-GR	3:1	Green	44.83	8.50	19.05	1.57	3.81	100	M61-R4310	M611, BMP61, BMP71
V	PSPT-187-175-OR	3:1	Orange	44.83	8.50	19.05	1.57	3.81	100	M61-R4310	M611, BMP61, BMP71
V	BM71-187-175-342-ORG	3:1	Orange	44.83	8.50	-	1.57	3.81	1000	M61-R4300	M611, BMP61, BMP71
V	PSPT-187-175-RD	3:1	Red	44.83	8.50	19.05	1.57	3.81	100	M61-R4310	M611, BMP61, BMP71
V	BM71-187-175-342-RD	3:1	Red	44.83	8.50	-	1.57	3.81	1000	M61-R4300	M611, BMP61, BMP71
V	PSPT-187-175-WT	3:1	White	44.83	8.50	19.05	1.57	3.81	100	M61-R4310	M611, BMP61, BMP71
V	BM71-187-175-342	3:1	White	44.83	8.50	-	1.57	3.81	1000	M61-R4300	M611, BMP61, BMP71
V	PSPT-187-175-YL	3:1	Yellow	44.83	8.50	19.05	1.57	3.81	100	M61-R4310	M611, BMP61, BMP71
V	BM71-187-175-342YL	3:1	Yellow	44.83	8.50	-	1.57	3.81	1000	M61-R4300	M611, BMP61, BMP71
Ⓞ	PSPT-187-2-BK-R	3:1	Black	50.80	8.50	19.05	1.57	3.81	70	M61-R6710-WT	M611, BMP61, BMP71
Ⓞ	PSPT-187-2-WT-R	3:1	White	50.80	8.50	19.05	1.57	3.81	70	M61-R4310	M611, BMP61, BMP71
Ⓞ	PSPT-187-2-YL-R	3:1	Yellow	50.80	8.50	19.05	1.57	3.81	70	M61-R4310	M611, BMP61, BMP71
V	PSPT-250-1-WT-2	3:1	White	12.89	11.15	22.22	2.39	5.46	200	M61-R4310	M611, BMP61, BMP71
V	PSPT-250-175-WT-3	3:1	White	14.94	11.15	22.22	2.39	5.46	300	M61-R4310	M611, BMP61, BMP71
V	PSPT-250-175-YL-2	3:1	Yellow	22.42	11.15	22.22	2.39	5.46	200	M61-R4310	M611, BMP61, BMP71
V	PSPT-250-1-BK	3:1	Black	25.78	11.15	22.22	2.39	5.46	100	M61-R6710-WT	M611, BMP61, BMP71
V	PSPT-250-1-OR	3:1	Orange	25.78	11.15	22.22	2.39	5.46	100	M61-R4310	M611, BMP61, BMP71
V	PSPT-250-1-PK	3:1	Pink	25.78	11.15	22.22	2.39	5.46	100	M61-R4310	M611, BMP61, BMP71
V	PSPT-250-1-RD	3:1	Red	25.78	11.15	22.22	2.39	5.46	100	M61-R4310	M611, BMP61, BMP71
V	PSPT-250-1-WT	3:1	White	25.78	11.15	22.22	2.39	5.46	100	M61-R4310	M611, BMP61, BMP71
V	BM71-250-1-342	3:1	White	25.78	11.15	-	2.39	5.46	1000	M61-R4300	M611, BMP61, BMP71
V	PSPT-250-1-YL	3:1	Yellow	25.78	11.15	22.22	2.39	5.46	100	M61-R4310	M611, BMP61, BMP71
V	BM71-250-1-342-YL	3:1	Yellow	25.78	11.15	-	2.39	5.46	1000	M61-R4300	M611, BMP61, BMP71
V	PSPT-250-175-GR	3:1	Green	44.83	11.15	22.22	2.39	5.46	100	M61-R4310	M611, BMP61, BMP71
V	PSPT-250-175-OR	3:1	Orange	44.83	11.15	22.22	2.39	5.46	100	M61-R4310	M611, BMP61, BMP71
V	PSPT-250-175-RD	3:1	Red	44.83	11.15	22.22	2.39	5.46	100	M61-R4310	M611, BMP61, BMP71
V	BM71-250-175-342-RD	3:1	Red	44.83	11.15	-	2.39	5.46	1000	M61-R4300	M611, BMP61, BMP71
V	PSPT-250-175-WT	3:1	White	44.83	11.15	22.22	2.39	5.46	100	M61-R4310	M611, BMP61, BMP71
V	BM71-250-175-342	3:1	White	44.83	11.15	-	2.39	5.46	1000	M61-R4300	M611, BMP61, BMP71
V	PSPT-250-175-YL	3:1	Yellow	44.83	11.15	22.22	2.39	5.46	100	M61-R4310	M611, BMP61, BMP71
V	BM71-250-175-342YL	3:1	Yellow	44.83	11.15	-	2.39	5.46	1000	M61-R4300	M611, BMP61, BMP71
Ⓞ	PSPT-250-2-BK-R	3:1	Black	50.80	11.15	22.22	2.39	5.46	70	M61-R6710-WT	M611, BMP61, BMP71
Ⓞ	PSPT-250-2-WT-R	3:1	White	50.80	11.15	22.22	2.39	5.46	70	M61-R4310	M611, BMP61, BMP71
Ⓞ	PSPT-250-2-YL-R	3:1	Yellow	50.80	11.15	22.22	2.39	5.46	70	M61-R4310	M611, BMP61, BMP71
V	PSPT-375-1-WT-2	3:1	White	12.89	16.38	25.40	3.18	8.13	200	M61-R4310	M611, BMP61, BMP71
V	PSPT-375-1-BL	3:1	Blue	25.78	16.38	25.40	3.18	8.13	100	M61-R4310	M611, BMP61, BMP71
V	PSPT-375-1-GY	3:1	Grey	25.78	16.38	25.40	3.18	8.13	100	M61-R4310	M611, BMP61, BMP71
V	PSPT-375-1-OR	3:1	Orange	25.78	16.38	25.40	3.18	8.13	100	M61-R4310	M611, BMP61, BMP71
V	PSPT-375-1-RD	3:1	Red	25.78	16.38	25.40	3.18	8.13	100	M61-R4310	M611, BMP61, BMP71

Order references beginning with "B" indicate bulk rolls. Order reference ending with "R" indicate that the sleeve is rotated on the liner.

>>



See pages 49-53 for a detailed material index.

## Wire & cable marking

### PermaSleeve Heat-shrink sleeve markers (continued)

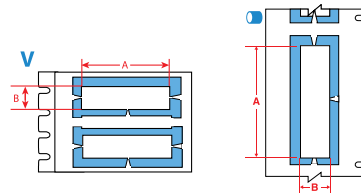

Diagram	Order Reference	Shrink Ratio	Colour	Sleeve Width A (mm)	Sleeve Height B (mm)	Vertical Repeat (mm)	Min. Wire Diameter (mm)	Max. Wire Diameter (mm)	Sleeves per roll	Printer Ribbon Series	Printer Compatibility
V	PSPT-375-1-WT	3:1	White	25.78	16.38	25.40	3.18	8.13	100	M61-R4310	M611, BMP61, BMP71
V	PSPT-375-1-YL	3:1	Yellow	25.78	16.38	25.40	3.18	8.13	100	M61-R4310	M611, BMP61, BMP71
V	PSPT-375-175-BL	3:1	Blue	44.83	16.38	25.40	3.18	8.13	100	M61-R4310	M611, BMP61, BMP71
V	PSPT-375-175-GR	3:1	Green	44.83	16.38	25.40	3.18	8.13	100	M61-R4310	M611, BMP61, BMP71
V	PSPT-375-175-OR	3:1	Orange	44.83	16.38	25.40	3.18	8.13	100	M61-R4310	M611, BMP61, BMP71
V	PSPT-375-175-PK	3:1	Pink	44.83	16.38	25.40	3.18	8.13	100	M61-R4310	M611, BMP61, BMP71
V	PSPT-375-175-RD	3:1	Red	44.83	16.38	25.40	3.18	8.13	100	M61-R4310	M611, BMP61, BMP71
V	PSPT-375-175-WT	3:1	White	44.83	16.38	25.40	3.18	8.13	100	M61-R4310	M611, BMP61, BMP71
V	PSPT-375-175-YL	3:1	Yellow	44.83	16.38	25.40	3.18	8.13	100	M61-R4310	M611, BMP61, BMP71
O	PSPT-375-2-BK-R	3:1	Black	50.80	16.38	25.40	3.18	8.13	70	M61-R6710-WT	M611, BMP61, BMP71
O	PSPT-375-2-WT-R	3:1	White	50.80	16.38	25.40	3.18	8.13	70	M61-R4310	M611, BMP61, BMP71
O	PSPT-375-2-YL-R	3:1	Yellow	50.80	16.38	25.40	3.18	8.13	70	M61-R4310	M611, BMP61, BMP71
V	BM71-375-1-342-2	3:1	White	12.70	16.40	-	3.18	8.13	2000	M61-R4300	M611, BMP61, BMP71
V	BM71-375-175-342-2	3:1	White	22.22	16.40	-	3.18	8.13	2000	M61-R4300	M611, BMP61, BMP71
V	BM71-375-1-342	3:1	White	25.78	16.40	-	3.18	8.13	1000	M61-R4300	M611, BMP61, BMP71
V	BM71-375-1-342-YL	3:1	Yellow	25.78	16.40	-	3.18	8.13	1000	M61-R4300	M611, BMP61, BMP71
V	BM71-375-175-342	3:1	White	44.83	16.40	-	3.18	8.13	1000	M61-R4300	M611, BMP61, BMP71
V	BM71-375-175-342-YL	3:1	Yellow	44.83	16.40	-	3.18	8.13	1000	M61-R4300	M611, BMP61, BMP71
V	BM71-500-175-342-YL-3	3:1	Yellow	14.94	21.60	-	4.75	11.43	3000	M61-R4300	M611, BMP61, BMP71
V	BM71-500-1-342	3:1	White	25.78	21.60	-	4.75	11.43	1000	M61-R4300	M611, BMP61, BMP71
V	BM71-500-1-342YL	3:1	Yellow	25.78	21.60	-	4.75	11.43	1000	M61-R4300	M611, BMP61, BMP71
V	BM71-500-175-342-RD	3:1	Red	44.83	21.60	-	4.75	11.43	1000	M61-R4310	M611, BMP61, BMP71
V	BM71-500-175-342	3:1	White	44.83	21.60	-	4.75	11.43	1000	M61-R4300	M611, BMP61, BMP71
V	BM71-500-175-342YL	3:1	Yellow	44.83	21.60	-	4.75	11.43	1000	M61-R4300	M611, BMP61, BMP71
V	PSPT-500-1-OR	3:1	Orange	25.78	21.61	31.75	4.75	11.43	100	M61-R4310	M611, BMP61, BMP71
V	PSPT-500-1-WT	3:1	White	25.78	21.61	31.75	4.75	11.43	100	M61-R4310	M611, BMP61, BMP71
V	PSPT-500-1-YL	3:1	Yellow	25.78	21.61	31.75	4.75	11.43	100	M61-R4310	M611, BMP61, BMP71
V	PSPT-500-175-BK	3:1	Black	44.83	21.61	31.75	4.75	11.43	100	M61-R6710-WT	M611, BMP61, BMP71
V	PSPT-500-175-BL	3:1	Blue	44.83	21.61	31.75	4.75	11.43	100	M61-R4310	M611, BMP61, BMP71
V	PSPT-500-175-BR	3:1	Brown	44.83	21.61	31.75	4.75	11.43	100	M61-R4310	M611, BMP61, BMP71
V	PSPT-500-175-GR	3:1	Green	44.83	21.61	31.75	4.75	11.43	100	M61-R4310	M611, BMP61, BMP71
V	PSPT-500-175-RD	3:1	Red	44.83	21.61	31.75	4.75	11.43	100	M61-R4310	M611, BMP61, BMP71
V	PSPT-500-175-WT	3:1	White	44.83	21.61	31.75	4.75	11.43	100	M61-R4310	M611, BMP61, BMP71
V	PSPT-500-175-YL	3:1	Yellow	44.83	21.61	31.75	4.75	11.43	100	M61-R4310	M611, BMP61, BMP71
O	PSPT-500-2-BK-R	3:1	Black	50.80	21.61	31.75	4.75	11.43	70	M61-R6710-WT	M611, BMP61, BMP71
O	PSPT-500-2-WT-R	3:1	White	50.80	21.61	31.75	4.75	11.43	70	M61-R4310	M611, BMP61, BMP71
O	PSPT-500-2-YL-R	3:1	Yellow	50.80	21.61	31.75	4.75	11.43	70	M61-R4310	M611, BMP61, BMP71
V	PSPT-750-1-WT	3:1	White	25.78	31.80	41.27	6.35	17.78	100	M61-R4310	M611, BMP61, BMP71
V	PSPT-750-1-YL	3:1	Yellow	25.78	31.80	41.27	6.35	17.78	100	M61-R4310	M611, BMP61, BMP71
V	PSPT-750-175-WT	3:1	White	44.83	31.80	41.27	6.35	17.78	100	M61-R4310	M611, BMP61, BMP71
V	PSPT-750-175-YL	3:1	Yellow	44.83	31.80	41.27	6.35	17.78	100	M61-R4310	M611, BMP61, BMP71
O	PSPT-750-2-BK-R	3:1	Black	50.80	31.80	41.27	6.35	17.78	70	M61-R6710-WT	M611, BMP61, BMP71
O	PSPT-750-2-WT-R	3:1	White	50.80	31.80	41.27	6.35	17.78	70	M61-R4310	M611, BMP61, BMP71
O	PSPT-750-2-YL-R	3:1	Yellow	50.80	31.80	41.27	6.35	17.78	70	M61-R4310	M611, BMP61, BMP71
V	PSPT-1000-1-WT	3:1	White	25.78	42.16	50.80	11.43	24.13	50	M61-R4310	M611, BMP61, BMP71
V	PSPT-1000-1-YL	3:1	Yellow	25.78	42.16	50.80	11.43	24.13	50	M61-R4310	M611, BMP61, BMP71
V	PSPT-1000-175-BK	3:1	Black	44.83	42.16	50.80	11.43	24.13	50	M61-R6710-WT	M611, BMP61, BMP71
V	PSPT-1000-175-BL	3:1	Blue	44.83	42.16	50.80	9.53	24.13	50	M61-R4310	M611, BMP61, BMP71
V	PSPT-1000-175-BR	3:1	Brown	44.83	42.16	50.80	11.43	24.13	50	M61-R4310	M611, BMP61, BMP71
V	PSPT-1000-175-GR	3:1	Green	44.83	42.16	50.80	11.43	24.13	50	M61-R4310	M611, BMP61, BMP71
V	PSPT-1000-175-GY	3:1	Grey	44.83	42.16	50.80	11.43	24.13	50	M61-R4310	M611, BMP61, BMP71
V	PSPT-1000-175-OR	3:1	Orange	44.83	42.16	50.80	11.43	24.13	50	M61-R4310	M611, BMP61, BMP71
V	PSPT-1000-175-PK	3:1	Pink	44.83	42.16	50.80	11.43	24.13	50	M61-R4310	M611, BMP61, BMP71
V	PSPT-1000-175-RD	3:1	Red	44.83	42.16	50.80	11.43	24.13	50	M61-R4310	M611, BMP61, BMP71
V	PSPT-1000-175-VT	3:1	Violet	44.83	42.16	50.80	11.43	24.13	50	M61-R4310	M611, BMP61, BMP71
V	PSPT-1000-175-WT	3:1	White	44.83	42.16	50.80	11.43	24.13	50	M61-R4310	M611, BMP61, BMP71
V	BM71-1000-175-342	3:1	White	44.83	42.16	-	9.53	24.13	500	M61-R4300	M611, BMP61, BMP71
V	PSPT-1000-175-YL	3:1	Yellow	44.83	42.16	50.80	11.43	24.13	50	M61-R4310	M611, BMP61, BMP71
O	PSPT-1000-2-BK-R	3:1	Black	50.80	42.16	50.80	11.43	24.13	70	M61-R6710-WT	M611, BMP61, BMP71
O	PSPT-1000-2-WT-R	3:1	White	50.80	42.16	50.80	11.43	24.13	70	M61-R4310	M611, BMP61, BMP71
O	PSPT-1000-2-YL-R	3:1	Yellow	50.80	42.16	50.80	11.43	24.13	70	M61-R4310	M611, BMP61, BMP71

Order references beginning with "B" indicate bulk rolls. Order reference ending with "R" indicate that the sleeve is rotated on the liner.

>>

Wire & cable marking

PermaSleeve Heat-shrink sleeve markers (continued)

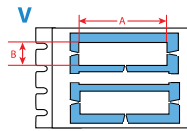
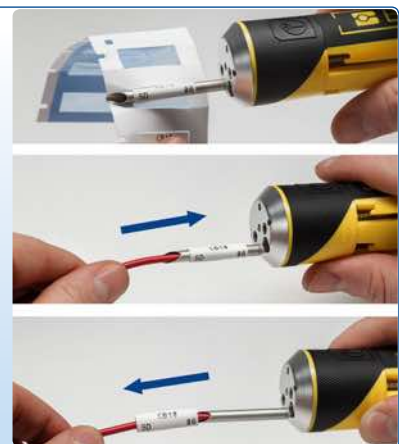

Diagram	Order Reference	Shrink Ratio	Colour	Sleeve Width A (mm)	Sleeve Height B (mm)	Vertical Repeat (mm)	Min. Wire Diameter (mm)	Max. Wire Diameter (mm)	Sleeves per roll	Printer Ribbon Series	Printer Compatibility
<b>B-345: High Temperature Heat-shrink Polyvinylidene Fluoride Sleeve</b>											
V	PSHT-094-1-WT	2:1	White	25.78	4.62	-	0.60	2.03	100	M61-R6610	M611, BMP61, BMP71
V	PSHT-094-1-YL	2:1	Yellow	25.78	4.62	-	0.60	2.03	100	M61-R6610	M611, BMP61, BMP71
V	PSHT-094-175-WT	2:1	White	44.83	4.62	-	0.08	2.03	100	M61-R6610	M611, BMP61, BMP71
V	PSHT-094-175-YL	2:1	Yellow	44.83	4.62	-	0.08	2.03	100	M61-R6610	M611, BMP61, BMP71
V	PSHT-125-1-BK	2:1	Black	25.78	5.96	-	1.17	2.79	100	M61-R4410-WT	M611, BMP61, BMP71
V	PSHT-125-1-BL	2:1	Blue	25.78	5.96	-	1.17	2.79	100	M61-R6610	M611, BMP61, BMP71
V	PSHT-125-1-PK	2:1	Pink	25.78	5.96	-	1.17	2.79	100	M61-R6610	M611, BMP61, BMP71
V	PSHT-125-1-WT	2:1	White	25.78	5.96	-	1.17	2.79	100	M61-R6610	M611, BMP61, BMP71
V	PSHT-125-1-YL	2:1	Yellow	25.78	5.96	-	1.17	2.79	100	M61-R6610	M611, BMP61, BMP71
V	PSHT-125-175-BL	2:1	Blue	44.83	5.96	-	1.17	2.79	100	M61-R6610	M611, BMP61, BMP71
V	PSHT-125-175-WT	2:1	White	44.83	5.96	-	1.17	2.79	100	M61-R6610	M611, BMP61, BMP71
V	PSHT-125-175-YL	2:1	Yellow	44.83	5.96	-	1.17	2.79	100	M61-R6610	M611, BMP61, BMP71
V	PSHT-187-1-WT	2:1	White	25.78	8.50	-	1.57	3.81	100	M61-R6610	M611, BMP61, BMP71
V	PSHT-187-1-YL	2:1	Yellow	25.78	8.50	-	1.57	3.81	100	M61-R6610	M611, BMP61, BMP71
V	PSHT-187-175-BL	2:1	Blue	44.83	8.50	-	1.57	3.81	100	M61-R6610	M611, BMP61, BMP71
V	PSHT-187-175-WT	2:1	White	44.83	8.50	-	1.57	3.81	100	M61-R6610	M611, BMP61, BMP71
V	PSHT-187-175-YL	2:1	Yellow	44.83	8.50	-	1.57	3.81	100	M61-R6610	M611, BMP61, BMP71
V	PSHT-250-1-WT	2:1	White	25.80	11.20	-	2.39	5.46	100	M61-R6610	M611, BMP61, BMP71
V	PSHT-250-1-YL	2:1	Yellow	25.80	11.20	-	2.39	5.46	100	M61-R6610	M611, BMP61, BMP71
V	PSHT-250-175-WT	2:1	White	44.80	11.20	-	2.39	5.46	100	M61-R6610	M611, BMP61, BMP71
V	PSHT-250-175-YL	2:1	Yellow	44.80	11.20	-	2.39	5.46	100	M61-R6610	M611, BMP61, BMP71
V	PSHT-375-1-WT	2:1	White	25.78	16.38	-	3.18	8.10	100	M61-R6610	M611, BMP61, BMP71
V	PSHT-375-1-YL	2:1	Yellow	25.78	16.38	-	3.18	8.10	100	M61-R6610	M611, BMP61, BMP71
V	PSHT-375-175-WT	2:1	White	44.83	16.38	-	3.18	8.10	100	M61-R6610	M611, BMP61, BMP71
V	PSHT-375-175-YL	2:1	Yellow	44.83	16.38	-	3.18	8.10	100	M61-R6610	M611, BMP61, BMP71
V	PSHT-500-1-WT	2:1	White	25.78	21.61	-	4.75	11.43	100	M61-R6610	M611, BMP61, BMP71
V	PSHT-500-1-YL	2:1	Yellow	25.78	21.61	-	4.75	11.43	100	M61-R6610	M611, BMP61, BMP71
V	PSHT-500-175-WT	2:1	White	44.83	21.61	-	4.75	11.43	100	M61-R6610	M611, BMP61, BMP71
V	PSHT-500-175-YL	2:1	Yellow	44.83	21.61	-	4.75	11.43	100	M61-R6610	M611, BMP61, BMP71
V	PSHT-750-1-WT	2:1	White	25.78	31.80	-	6.35	17.78	100	M61-R6610	M611, BMP61, BMP71
V	PSHT-750-1-YL	2:1	Yellow	25.78	31.80	-	6.35	17.78	100	M61-R6610	M611, BMP61, BMP71
V	PSHT-750-175-WT	2:1	White	44.83	31.80	-	6.35	17.78	100	M61-R6610	M611, BMP61, BMP71
V	PSHT-750-175-YL	2:1	Yellow	44.83	31.80	-	6.35	17.78	100	M61-R6610	M611, BMP61, BMP71
V	PSHT-1000-1-WT	2:1	White	25.78	42.16	-	11.43	24.13	50	M61-R6610	M611, BMP61, BMP71
V	PSHT-1000-1-YL	2:1	Yellow	25.78	42.16	-	11.43	24.13	50	M61-R6610	M611, BMP61, BMP71
V	PSHT-1000-175-WT	2:1	White	44.83	42.16	-	11.43	24.13	50	M61-R6610	M611, BMP61, BMP71
V	PSHT-1000-175-YL	2:1	Yellow	44.83	42.16	-	11.43	24.13	50	M61-R6610	M611, BMP61, BMP71

Easily and quickly apply reliable cable sleeves



Cable sleeves are a reliable and sturdy solution to identify cables. Applying a cable sleeve is not always easy, especially when you want to identify thin cables using tiny sleeves. With our QuickSleeve handheld sleeve applicator, applying sleeves becomes a lot faster and easier. For more information, visit [www.bradyeurope.com/QuickSleeve](http://www.bradyeurope.com/QuickSleeve)



See pages 49-53 for a detailed material index.

## Wire & cable marking



### Self-laminating labels

- Features a clear, non-printable area that wraps around the cable and serves as an overlamine to the printed text.
- Offers superior resistance to abrasion, dirt, oils, solvents and water.

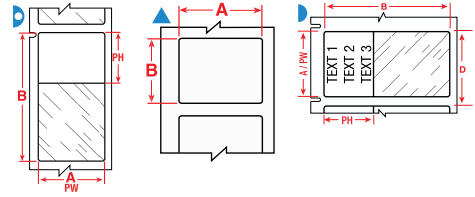

Diagram	Order Reference	Colour	Label Width A (mm)	Label Height B (mm)	Printable Area Width PW (mm)	Printable Area Height PH (mm)	Vertical Repeat D (mm)	Min. Wire Diameter (mm)	Max. Wire Diameter (mm)	Labels per Roll	Printer Ribbon Series	Printer Compatibility
<b>B-427: Self-laminating Vinyl</b>												
▶	PTL-10-427	White/Transparent	6.35	19.05	6.35	9.53	9.53	2.00	3.00	750	M61-R4310	M611, BMP61, BMP71
▶	PTL-10-427-YL	Yellow/Transparent	6.35	19.05	6.35	9.53	9.53	2.00	3.00	750	M61-R4310	M611, BMP61, BMP71
▲	PTL-28-427	White/Transparent	6.35	38.10	6.35	12.70	9.53	4.00	8.10	750	M61-R4310	M611, BMP61, BMP71
▶	PTL-28-427-YL	Yellow/Transparent	6.35	38.10	6.35	12.70	9.53	4.00	8.10	750	M61-R4310	M611, BMP61, BMP71
▶	PTL-28-427-OR	Orange/Transparent	6.35	38.10	6.35	12.70	9.53	4.00	8.10	750	M61-R4310	M611, BMP61, BMP71
▶	PTL-28-427-GR	Green/Transparent	6.35	38.10	6.35	12.70	9.53	4.00	8.10	750	M61-R4310	M611, BMP61, BMP71
▶	PTL-28-427-GY	Grey/Transparent	6.35	38.10	6.35	12.70	9.53	4.00	8.10	750	M61-R4310	M611, BMP61, BMP71
▶	PTL-28-427-PL	Purple/Transparent	6.35	38.10	6.35	12.70	9.53	4.00	8.10	750	M61-R4310	M611, BMP61, BMP71
▶	PTL-28-427-BL	Blue/Transparent	6.35	38.10	6.35	12.70	9.53	4.00	8.10	750	M61-R4310	M611, BMP61, BMP71
▶	PTL-28-427-BR	Brown/Transparent	6.35	38.10	6.35	12.70	9.53	4.00	8.10	750	M61-R4310	M611, BMP61, BMP71
▶	PTL-28-427-RD	Red/Transparent	6.35	38.10	6.35	12.70	9.53	4.00	8.10	750	M61-R4310	M611, BMP61, BMP71
▶	PTL-11-427	White/Transparent	12.70	19.05	12.70	9.53	15.87	2.70	3.03	500	M61-R4310	M611, BMP61, BMP71
▶	PTL-11-427-YL	Yellow/Transparent	12.70	19.05	12.70	9.53	15.87	2.70	3.03	500	M61-R4310	M611, BMP61, BMP71
▶	BM71-11-427	White/Transparent	12.70	19.05	12.70	9.53	15.88	2.00	3.00	5000	M61-R4310	M611, BMP61, BMP71
▶	PTL-17-427	White/Transparent	12.70	25.40	12.70	9.53	15.87	3.00	5.05	500	M61-R4310	M611, BMP61, BMP71
▶	PTL-17-427-YL	Yellow/Transparent	12.70	25.40	12.70	9.53	15.87	3.00	5.05	500	M61-R4310	M611, BMP61, BMP71
▶	BM71-17-427	White/Transparent	12.70	25.40	12.70	9.53	15.88	2.70	5.10	5000	M61-R4310	M611, BMP61, BMP71
▶	PTL-102-427	White/Transparent	12.70	31.75	12.70	9.53	34.93	3.40	7.10	250	M61-R4310	M611, BMP61, BMP71
▶	PTL-29-427	White/Transparent	12.70	38.10	12.70	12.70	15.88	4.00	8.10	500	M61-R4310	M611, BMP61, BMP71
▶	PTL-29-427-YL	Yellow/Transparent	12.70	38.10	12.70	12.70	15.88	4.00	8.10	500	M61-R4310	M611, BMP61, BMP71
▶	PTL-29-427-OR	Orange/Transparent	12.70	38.10	12.70	12.70	15.88	4.00	8.10	500	M61-R4310	M611, BMP61, BMP71
▶	PTL-29-427-GR	Green/Transparent	12.70	38.10	12.70	12.70	15.88	4.00	8.10	500	M61-R4310	M611, BMP61, BMP71
▶	PTL-29-427-GY	Grey/Transparent	12.70	38.10	12.70	12.70	15.88	4.00	8.10	500	M61-R4310	M611, BMP61, BMP71
▶	PTL-29-427-PL	Purple/Transparent	12.70	38.10	12.70	12.70	15.88	4.00	8.10	500	M61-R4310	M611, BMP61, BMP71
▶	PTL-29-427-BL	Blue/Transparent	12.70	38.10	12.70	12.70	15.88	4.00	8.10	500	M61-R4310	M611, BMP61, BMP71
▶	PTL-29-427-BR	Brown/Transparent	12.70	38.10	12.70	12.70	15.88	4.00	8.10	500	M61-R4310	M611, BMP61, BMP71
▶	PTL-29-427-RD	Red/Transparent	12.70	38.10	12.70	12.70	15.88	4.00	8.10	500	M61-R4310	M611, BMP61, BMP71
▶	BM71-29-427	White/Transparent	12.70	38.10	12.70	12.70	15.88	4.00	8.10	5000	M61-R4310	M611, BMP61, BMP71
▶	PTL-74-427	White/Transparent	12.70	55.88	12.70	19.05	60.33	5.90	11.70	100	M61-R4310	M611, BMP61, BMP71
▶	PTL-18-427	White/Transparent	19.05	25.40	19.05	9.53	22.23	2.70	5.05	250	M61-R4310	M611, BMP61, BMP71
▶	PTL-18-427-YL	Yellow/Transparent	19.05	25.40	19.05	9.53	22.23	2.70	5.05	250	M61-R4310	M611, BMP61, BMP71
▶	BM71-18-427	White/Transparent	19.05	25.40	19.05	9.53	22.23	2.70	5.10	2500	M61-R4310	M611, BMP61, BMP71
▶	PTL-30-427	White/Transparent	19.05	38.10	19.05	12.70	22.23	4.00	8.10	250	M61-R4310	M611, BMP61, BMP71
▶	PTL-30-427-YL	Yellow/Transparent	19.05	38.10	19.05	12.70	22.23	4.00	8.10	250	M61-R4310	M611, BMP61, BMP71
▶	PTL-30-427-OR	Orange/Transparent	19.05	38.10	19.05	12.70	22.23	4.00	8.10	250	M61-R4310	M611, BMP61, BMP71
▶	PTL-30-427-GR	Green/Transparent	19.05	38.10	19.05	12.70	22.23	4.00	8.10	250	M61-R4310	M611, BMP61, BMP71
▶	PTL-30-427-GY	Grey/Transparent	19.05	38.10	19.05	12.70	22.23	4.00	8.10	250	M61-R4310	M611, BMP61, BMP71
▶	PTL-30-427-PL	Purple/Transparent	19.05	38.10	19.05	12.70	22.23	4.00	8.10	250	M61-R4310	M611, BMP61, BMP71
▶	PTL-30-427-BL	Blue/Transparent	19.05	38.10	19.05	12.70	22.23	4.00	8.10	250	M61-R4310	M611, BMP61, BMP71
▶	PTL-30-427-BR	Brown/Transparent	19.05	38.10	19.05	12.70	22.23	4.00	8.10	250	M61-R4310	M611, BMP61, BMP71
▶	PTL-30-427-RD	Red/Transparent	19.05	38.10	19.05	12.70	22.23	4.00	8.10	250	M61-R4310	M611, BMP61, BMP71
▶	BM71-30-427	White/Transparent	19.05	38.10	19.05	12.70	22.23	4.00	8.10	2500	M61-R4310	M611, BMP61, BMP71

Order references beginning with "B" indicate bulk rolls. \*Order references ending with "AW" indicate all white labels with no clear area.

>>

Apply the printed area to your wire.

Wrap the clear area around the wire, covering the printed area.

Once applied the clear laminate will protect your legend for years to come.

## Self-laminating labels (continued)

Diagram	Order Reference	Colour	Label Width A (mm)	Label Height B (mm)	Printable Area Width PW (mm)	Printable Area Height PH (mm)	Vertical Repeat D (mm)	Min. Wire Diameter (mm)	Max. Wire Diameter (mm)	Labels per Roll	Printer Ribbon Series	Printer Compatibility
▶	PTL-96-427	White/Transparent	25.40	19.05	25.40	9.53	28.57	2.70	5.10	250	M61-R4310	M611, BMP61, BMP71
▶	PTL-19-427	White/Transparent	25.40	25.40	25.40	9.53	28.58	3.00	5.05	250	M61-R4310	M611, BMP61, BMP71
▶	PTL-19-427-YL	Yellow/Transparent	25.40	25.40	25.40	9.53	28.58	3.00	5.05	250	M61-R4310	M611, BMP61, BMP71
▶	PTL-19-427-OR	Orange/Transparent	25.40	25.40	25.40	9.53	28.58	3.00	5.05	250	M61-R4310	M611, BMP61, BMP71
▶	PTL-19-427-GR	Green/Transparent	25.40	25.40	25.40	9.53	28.58	3.00	5.05	250	M61-R4310	M611, BMP61, BMP71
▶	PTL-19-427-GY	Grey/Transparent	25.40	25.40	25.40	9.53	28.58	3.00	5.05	250	M61-R4310	M611, BMP61, BMP71
▶	PTL-19-427-PL	Purple/Transparent	25.40	25.40	25.40	9.53	28.58	3.00	5.05	250	M61-R4310	M611, BMP61, BMP71
▶	PTL-19-427-BL	Blue/Transparent	25.40	25.40	25.40	9.53	28.58	3.00	5.05	250	M61-R4310	M611, BMP61, BMP71
▶	PTL-19-427-BR	Brown/Transparent	25.40	25.40	25.40	9.53	28.58	3.00	5.05	250	M61-R4310	M611, BMP61, BMP71
▶	PTL-19-427-RD	Red/Transparent	25.40	25.40	25.40	9.53	28.58	3.00	5.05	250	M61-R4310	M611, BMP61, BMP71
▶	BM71-19-427	White/Transparent	25.40	25.40	25.40	9.53	28.58	2.70	5.10	2500	M61-R4310	M611, BMP61, BMP71
▶	PTL-103-427	White/Transparent	25.40	31.75	25.40	12.70	34.93	3.40	6.10	250	M61-R4310	M611, BMP61, BMP71
▶	PTL-31-427	White/Transparent	25.40	38.10	25.40	12.70	28.58	4.00	8.10	250	M61-R4310	M611, BMP61, BMP71
▶	PTL-31-427-YL	Yellow/Transparent	25.40	38.10	25.40	12.70	28.58	4.00	8.10	250	M61-R4310	M611, BMP61, BMP71
▶	PTL-31-427-OR	Orange/Transparent	25.40	38.10	25.40	12.70	28.58	4.00	8.10	250	M61-R4310	M611, BMP61, BMP71
▶	PTL-31-427-GR	Green/Transparent	25.40	38.10	25.40	12.70	28.58	4.00	8.10	250	M61-R4310	M611, BMP61, BMP71
▶	PTL-31-427-GY	Grey/Transparent	25.40	38.10	25.40	12.70	28.58	4.00	8.10	250	M61-R4310	M611, BMP61, BMP71
▶	PTL-31-427-PL	Purple/Transparent	25.40	38.10	25.40	12.70	28.58	4.00	8.10	250	M61-R4310	M611, BMP61, BMP71
▶	PTL-31-427-BL	Blue/Transparent	25.40	38.10	25.40	12.70	28.58	4.00	8.10	250	M61-R4310	M611, BMP61, BMP71
▶	PTL-31-427-BR	Brown/Transparent	25.40	38.10	25.40	12.70	28.58	4.00	8.10	250	M61-R4310	M611, BMP61, BMP71
▶	PTL-31-427-RD	Red/Transparent	25.40	38.10	25.40	12.70	28.58	4.00	8.10	250	M61-R4310	M611, BMP61, BMP71
▶	BM71-31-427	White/Transparent	25.40	38.10	25.40	12.70	28.58	4.00	8.10	2500	M61-R4310	M611, BMP61, BMP71
▶	PTL-21-427	White/Transparent	25.40	63.50	25.40	19.05	66.68	6.70	14.20	100	M61-R4310	M611, BMP61, BMP71
▶	PTL-21-427-YL	Yellow/Transparent	25.40	63.50	25.40	19.05	66.68	6.70	14.20	100	M61-R4310	M611, BMP61, BMP71
▶	PTL-21-427-OR	Orange/Transparent	25.40	63.50	25.40	19.05	66.68	6.70	14.20	100	M61-R4310	M611, BMP61, BMP71
▶	PTL-21-427-GR	Green/Transparent	25.40	63.50	25.40	19.05	66.68	6.70	14.20	100	M61-R4310	M611, BMP61, BMP71
▶	PTL-21-427-GY	Grey/Transparent	25.40	63.50	25.40	19.05	66.68	6.70	14.20	100	M61-R4310	M611, BMP61, BMP71
▶	PTL-21-427-PL	Purple/Transparent	25.40	63.50	25.40	19.05	66.68	6.70	14.20	100	M61-R4310	M611, BMP61, BMP71
▶	PTL-21-427-BL	Blue/Transparent	25.40	63.50	25.40	19.05	66.68	6.70	14.20	100	M61-R4310	M611, BMP61, BMP71
▶	PTL-21-427-BR	Brown/Transparent	25.40	63.50	25.40	19.05	66.68	6.70	14.20	100	M61-R4310	M611, BMP61, BMP71
▶	PTL-21-427-RD	Red/Transparent	25.40	63.50	25.40	19.05	66.68	6.70	14.20	100	M61-R4310	M611, BMP61, BMP71
▶	BM71-21-427	White/Transparent	25.40	63.50	25.40	19.05	66.68	6.70	14.20	1000	M61-R4310	M611, BMP61, BMP71
▶	PTL-75-427	White/Transparent	25.40	66.68	25.40	25.40	69.85	7.10	13.10	100	M61-R4310	M611, BMP61, BMP71
★	PTL-64-427	White/Transparent	25.40	85.73	25.40	28.58	88.90	9.10	18.20	100	M61-R4310	M611, BMP61, BMP71
★	BM71-64-427	White/Transparent	25.40	85.73	25.40	28.58	88.90	9.10	18.20	1000	M61-R4310	M611, BMP61, BMP71
▶	PTL-23-427	White/Transparent	25.40	101.60	25.40	25.40	104.78	10.80	24.30	100	M61-R4310	M611, BMP61, BMP71
▶	PTL-23-427-YL	Yellow/Transparent	25.40	101.60	25.40	25.40	104.78	10.80	24.30	100	M61-R4310	M611, BMP61, BMP71
▶	PTL-23-427-OR	Orange/Transparent	25.40	101.60	25.40	25.40	104.78	10.80	24.30	100	M61-R4310	M611, BMP61, BMP71
▶	PTL-23-427-GR	Green/Transparent	25.40	101.60	25.40	25.40	104.78	10.80	24.30	100	M61-R4310	M611, BMP61, BMP71
▶	PTL-23-427-GY	Grey/Transparent	25.40	101.60	25.40	25.40	104.78	10.80	24.30	100	M61-R4310	M611, BMP61, BMP71
▶	PTL-23-427-PL	Purple/Transparent	25.40	101.60	25.40	25.40	104.78	10.80	24.30	100	M61-R4310	M611, BMP61, BMP71
▶	PTL-23-427-BL	Blue/Transparent	25.40	101.60	25.40	25.40	104.78	10.80	24.30	100	M61-R4310	M611, BMP61, BMP71
▶	PTL-23-427-BR	Brown/Transparent	25.40	101.60	25.40	25.40	104.78	10.80	24.30	100	M61-R4310	M611, BMP61, BMP71
▶	PTL-23-427-RD	Red/Transparent	25.40	101.60	25.40	25.40	104.78	10.80	24.30	100	M61-R4310	M611, BMP61, BMP71
▶	BM71-23-427	White/Transparent	25.40	101.60	25.40	25.40	104.78	10.80	24.30	1000	M61-R4310	M611, BMP61, BMP71
▲	PTL-105-427-AW	White	27.94	6.35	27.94	6.35	9.53	-	-	750	M61-R4310	M611, BMP61, BMP71
▲	PTL-106-427	White/Transparent	38.10	**	12.70	-	-	4.00	8.10	1	M61-R4310	M611, BMP61, BMP71
▲	PTL-30-427-AW*	White	38.10	19.05	38.10	19.05	22.23	4.00	8.00	250	M61-R4310	M611, BMP61, BMP71
▶	PTL-104-427	White/Transparent	38.10	25.40	38.10	9.53	28.57	2.70	5.10	250	M61-R4310	M611, BMP61, BMP71
▶	PTL-32-427	White/Transparent	38.10	38.10	38.10	12.70	41.28	4.00	8.10	250	M61-R4310	M611, BMP61, BMP71
▶	PTL-32-427-YL	Yellow/Transparent	38.10	38.10	38.10	12.70	41.28	4.00	8.10	250	M61-R4310	M611, BMP61, BMP71
▶	PTL-32-427-OR	Orange/Transparent	38.10	38.10	38.10	12.70	41.27	4.00	8.10	250	M61-R4310	M611, BMP61, BMP71
▶	PTL-32-427-GR	Green/Transparent	38.10	38.10	38.10	12.70	41.27	4.00	8.10	250	M61-R4310	M611, BMP61, BMP71
▶	PTL-32-427-GY	Grey/Transparent	38.10	38.10	38.10	12.70	41.27	4.00	8.10	250	M61-R4310	M611, BMP61, BMP71
▶	PTL-32-427-PL	Purple/Transparent	38.10	38.10	38.10	12.70	41.27	4.00	8.10	250	M61-R4310	M611, BMP61, BMP71
▶	PTL-32-427-BL	Blue/Transparent	38.10	38.10	38.10	12.70	41.27	4.00	8.10	250	M61-R4310	M611, BMP61, BMP71
▶	PTL-32-427-BR	Brown/Transparent	38.10	38.10	38.10	12.70	41.27	4.00	8.10	250	M61-R4310	M611, BMP61, BMP71
▶	PTL-32-427-RD	Red/Transparent	38.10	38.10	38.10	12.70	41.28	4.00	8.10	250	M61-R4310	M611, BMP61, BMP71

Order references beginning with "B" indicate bulk rolls. \*Order references ending with "AW" indicate all white labels with no clear area. >>

\*\*PTL-106-427: continuous material, length 15.24 m.

## Wire & cable marking



### Self-laminating labels (continued)

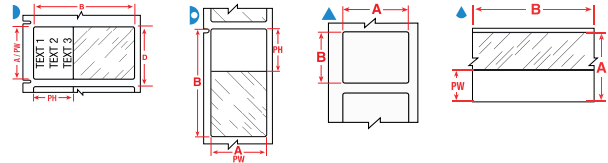

Diagram	Order Reference	Colour	Label Width A (mm)	Label Height B (mm)	Printable Area Width PW (mm)	Printable Area Height PH (mm)	Vertical Repeat D (mm)	Min. Wire Diameter (mm)	Max. Wire Diameter (mm)	Labels per Roll	Printer Ribbon Series	Printer Compatibility
▶	BM71-32-427	White/Transparent	38.10	38.10	38.10	12.70	41.28	4.00	8.10	1000	M61-R4310	M611, BMP61, BMP71
▶	PTL-33-427	White/Transparent	38.10	101.60	38.10	25.40	104.78	10.80	24.30	100	M61-R4310	M611, BMP61, BMP71
▶	PTL-33-427-YL	Yellow/Transparent	38.10	101.60	38.10	25.40	104.78	10.80	24.30	100	M61-R4310	M611, BMP61, BMP71
▶	PTL-33-427-OR	Orange/Transparent	38.10	101.60	38.10	25.40	104.78	10.80	24.30	100	M61-R4310	M611, BMP61, BMP71
▶	PTL-33-427-GR	Green/Transparent	38.10	101.60	38.10	25.40	104.78	10.80	24.30	100	M61-R4310	M611, BMP61, BMP71
▶	PTL-33-427-GY	Grey/Transparent	38.10	101.60	38.10	25.40	104.78	10.80	24.30	100	M61-R4310	M611, BMP61, BMP71
▶	PTL-33-427-PL	Purple/Transparent	38.10	101.60	38.10	25.40	104.78	10.80	24.30	100	M61-R4310	M611, BMP61, BMP71
▶	PTL-33-427-BL	Blue/Transparent	38.10	101.60	38.10	25.40	104.78	10.80	24.30	100	M61-R4310	M611, BMP61, BMP71
▶	PTL-33-427-BR	Brown/Transparent	38.10	101.60	38.10	25.40	104.78	10.80	24.30	100	M61-R4310	M611, BMP61, BMP71
▶	PTL-33-427-RD	Red/Transparent	38.10	101.60	38.10	25.40	104.78	10.80	24.30	100	M61-R4310	M611, BMP61, BMP71
▶	PTL-109-427	White/Transparent	38.10	101.60	38.10	38.10	104.78	12.12	20.20	100	M61-R4310	M611, BMP61, BMP71
▶	BM71-33-427	White/Transparent	38.10	101.60	38.10	25.40	104.78	10.80	24.30	500	M61-R4310	M611, BMP61, BMP71
▶	BM71-109-427	White/Transparent	38.10	101.60	38.10	38.10	104.78	10.80	20.20	500	M61-R4310	M611, BMP61, BMP71
▶	PTL-34-427	White/Transparent	38.10	152.40	38.10	38.10	155.58	16.20	36.40	50	M61-R4310	M611, BMP61, BMP71
▶	PTL-34-427-YL	Yellow/Transparent	38.10	152.40	38.10	38.10	155.58	16.20	36.40	50	M61-R4310	M611, BMP61, BMP71
▶	PTL-34-427-OR	Orange/Transparent	38.10	152.40	38.10	38.10	155.58	16.20	36.40	50	M61-R4310	M611, BMP61, BMP71
▶	PTL-34-427-GR	Green/Transparent	38.10	152.40	38.10	38.10	155.58	16.20	36.40	50	M61-R4310	M611, BMP61, BMP71
▶	PTL-34-427-GY	Grey/Transparent	38.10	152.40	38.10	38.10	155.58	16.20	36.40	50	M61-R4310	M611, BMP61, BMP71
▶	PTL-34-427-PL	Purple/Transparent	38.10	152.40	38.10	38.10	155.58	16.20	36.40	50	M61-R4310	M611, BMP61, BMP71
▶	PTL-34-427-BL	Blue/Transparent	38.10	152.40	38.10	38.10	155.58	16.20	36.40	50	M61-R4310	M611, BMP61, BMP71
▶	PTL-34-427-BR	Brown/Transparent	38.10	152.40	38.10	38.10	155.58	16.20	36.40	50	M61-R4310	M611, BMP61, BMP71
▶	PTL-34-427-RD	Red/Transparent	38.10	152.40	38.10	38.10	155.58	16.20	36.40	50	M61-R4310	M611, BMP61, BMP71
▶	BM71-34-427	White/Transparent	38.10	152.40	38.10	38.10	155.58	16.20	36.40	500	M61-R4310	M611, BMP61, BMP71
▶	PTL-87-427	White/Transparent	44.45	25.40	44.45	9.53	28.57	2.70	5.10	250	M61-R4310	M611, BMP61, BMP71
▶	PTL-88-427	White/Transparent	44.45	38.10	44.45	12.70	41.27	4.00	8.10	250	M61-R4310	M611, BMP61, BMP71
▲	PTL-78-427-AW*	White	48.26	25.40	48.26	25.40	28.58	-	-	250	M61-R4310	M611, BMP61, BMP71
▶	PTL-66-427	White/Transparent	49.28	80.00	49.28	25.40	83.57	8.50	17.40	100	M61-R4310	M611, BMP61, BMP71
▶	PTL-107-427	White/Transparent	50.80	38.10	50.80	12.70	53.97	4.00	8.10	100	M61-R4310	M611, BMP61, BMP71
▶	BM71-107-427	White/Transparent	50.80	38.10	50.80	12.70	53.98	4.00	8.10	1000	M61-R4310	M611, BMP61, BMP71
<b>B-642: Polyvinylfluoride</b>												
▶	PTL-19-642	White/Transparent	25.40	25.40	25.40	9.53	28.57	2.70	5.10	250	M61-R4310	M611, BMP61, BMP71
▶	PTL-31-642	White/Transparent	25.40	38.10	25.40	12.70	41.27	4.00	8.10	250	M61-R4310	M611, BMP61, BMP71
▶	PTL-21-642	White/Transparent	25.40	63.50	25.40	19.05	66.68	6.70	14.20	100	M61-R4310	M611, BMP61, BMP71

Order references beginning with "B" indicate bulk rolls. \*Order references ending with "AW" indicate all white labels with no clear area.

## Wire & cable marking

### Wrap around labels

- These durable cloth wrap around labels are available with either an adhesive that allows the markers to be removed cleanly and reapplied if necessary (B-498) or with a permanent adhesive (B-437, B-499).
- A 3 mm overlap is recommended with these materials for an ideal, long lasting solution.

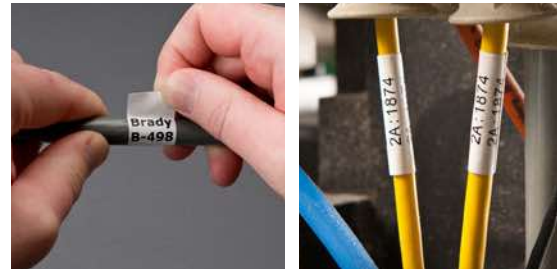
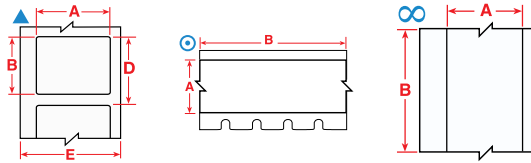

Diagram	Order Reference	Colour	Label Width A (mm)	Label Height B (mm)	Label Length B (m)	Vertical Repeat D (mm)	Max. Wire Diameter (mm)	Labels per Roll	Printer Ribbon Series	Printer Compatibility
<b>B-437: Polyvinylfluoride</b>										
▲	PTL-9-437	White	16.51	5.08	-	8.25	4.29	750	M61-R4310	BMP61, BMP71, M611
▲	PTL-10-437	White	19.05	6.35	-	9.53	5.10	750	M61-R4310	BMP61, BMP71, M611
▲	PTL-15-437	White	25.40	6.99	-	10.16	7.12	750	M61-R4310	BMP61, BMP71, M611
◎	PTLCM-41-437-WT	White	38.10	-	15.24	-	-	1	M61-R4310	BMP61, BMP71, M611
◎	PTLCM-41-437-YL	Yellow	38.10	-	15.24	-	-	1	M61-R4310	BMP61, BMP71, M611
▲	PTL-29-437	White	38.10	12.70	-	15.87	11.16	500	M61-R4310	BMP61, BMP71, M611
<b>B-498: Vinyl Cloth</b>										
▲	PTL-10-498	White	6.35	19.05	-	22.22	5.11	750	M61-R6210	BMP61, BMP71, M611
▲	PTL-16-498	White	9.53	25.40	-	28.57	7.13	500	M61-R6210	BMP61, BMP71, M611
∞	PTL-8-498	White	12.70	-	9.10	-	-	1	M61-R6210	BMP61, BMP71, M611
▲	PTL-7-498	White	12.70	12.70	-	15.87	3.09	500	M61-R6210	BMP61, BMP71, M611
▲	PTL-11-498	White	12.70	19.05	-	22.22	5.11	500	M61-R6210	BMP61, BMP71, M611
▲	BM71-11-498	White	19.05	12.70	-	15.88	4.55	5000	R6200	BMP61, BMP71, M611
▲	PTL-18-498	White	19.05	25.40	-	28.57	7.13	250	M61-R6210	BMP61, BMP71, M611
▲	PTL-23-498	White	25.40	101.60	-	104.77	31.37	100	M61-R6210	BMP61, BMP71, M611
▲	PTL-17-498	White	25.40	12.70	-	15.87	3.09	500	M61-R6210	BMP61, BMP71, M611
▲	BM71-18-498	White	25.40	19.05	-	22.23	6.06	2500	R6200	BMP61, BMP71, M611
▲	PTL-19-498	White	25.40	25.40	-	28.57	7.13	250	M61-R6210	BMP61, BMP71, M611
▲	BM71-19-498	White	25.40	25.40	-	28.58	6.06	2500	R6200	BMP61, BMP71, M611
▲	PTL-15-498	White	25.40	6.99	-	10.16	7.12	750	M61-R6210	BMP61, BMP71, M611
▲	PTL-21-498	White	25.40	63.50	-	66.67	19.25	100	M61-R6210	BMP61, BMP71, M611
▲	PTL-33-498	White	38.10	101.60	-	104.77	31.37	100	M61-R6210	BMP61, BMP71, M611
▲	PTL-29-498	White	38.10	12.70	-	15.87	11.17	500	M61-R6210	BMP61, BMP71, M611
▲	BM71-29-498	White	38.10	12.70	-	15.88	9.10	5000	R6200	BMP61, BMP71, M611
▲	PTL-34-498	White	38.10	152.40	-	155.57	47.53	50	M61-R6210	BMP61, BMP71, M611
▲	PTL-30-498	White	38.10	19.05	-	22.22	11.17	250	M61-R6210	BMP61, BMP71, M611
▲	PTL-31-498	White	38.10	25.40	-	28.57	11.17	250	M61-R6210	BMP61, BMP71, M611
▲	PTL-32-498	White	38.10	38.10	-	41.27	11.17	250	M61-R6210	BMP61, BMP71, M611
▲	PTL-28-498	White	38.10	6.35	-	9.53	11.17	750	M61-R6210	BMP61, BMP71, M611
<b>B-499: Nylon Cloth</b>										
▲	PTL-16-499	White	9.53	25.40	-	28.57	7.13	500	M61-R4310	BMP61, BMP71, M611
▲	PTL-7-499	White	12.70	12.70	-	15.87	3.09	500	M61-R4310	BMP61, BMP71, M611
▲	PTL-11-499	White	12.70	19.05	-	22.22	5.11	500	M61-R4310	BMP61, BMP71, M611
▲	BM71-11-499	White	19.05	12.70	-	15.88	4.55	5000	R4300	BMP61, BMP71, M611
▲	PTL-18-499	White	19.05	25.40	-	28.57	7.13	250	M61-R4310	BMP61, BMP71, M611
▲	PTL-84-499	White	22.86	12.70	-	15.87	-	500	M61-R4310	BMP61, BMP71, M611
▲	PTL-23-499	White	25.40	101.60	-	104.77	31.37	100	M61-R4310	BMP61, BMP71, M611
▲	PTL-19-499	White	25.40	25.40	-	28.57	7.13	250	M61-R4310	BMP61, BMP71, M611
▲	PTL-21-499	White	25.40	63.50	-	66.67	-	100	M61-R4310	BMP61, BMP71, M611
▲	PTL-29-499	White	38.10	12.70	-	15.87	11.17	500	M61-R4310	BMP61, BMP71, M611
▲	PTL-30-499	White	38.10	19.05	-	22.22	11.16	250	M61-R4310	BMP61, BMP71, M611
▲	PTL-31-499	White	38.10	25.40	-	28.57	11.17	250	M61-R4310	BMP61, BMP71, M611
▲	PTL-28-499	White	38.10	6.35	-	9.53	11.17	750	M61-R4310	BMP61, BMP71, M611
▲	PTL-78-499	White	48.26	25.40	-	28.57	-	250	M61-R4310	BMP61, BMP71, M611
▲	PTL-81-499	White	48.26	6.35	-	9.53	14.40	750	M61-R4310	BMP61, BMP71, M611

Order references beginning with "B" indicate bulk rolls.



See pages 49-53 for a detailed material index.

## Wire & cable marking



### Fibre optic labels/flags

- These fibre optic flags allow more legible information to be printed on smaller diameter wires and permit you to handle and view labels without touching the wires.

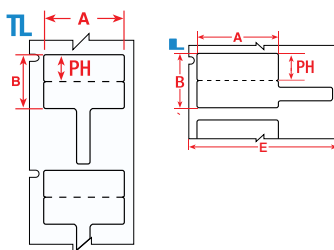

Diagram	Order Reference	Colour	Label Width A (mm)	Label Height B (mm)	Printable Area Height PH (mm)	Vertical Repeat D (mm)	Labels per Roll	Printer Ribbon Series	Printer Compatibility
B-425A: Polypropylene									
	PTLFP-01-425	White	30.00	20.00	10.00	23.28	250	M61-R4310	BMP61, BMP71, M611
	PTLFT-01-425	White	30.00	20.00	10.00	43.39	250	M61-R4310	BMP61, BMP71, M611



### RAPIDO plastic wiremarkers

- Yellow coated polyethylene tag suitable for durable wire marking for electrical devices and fibre installations.

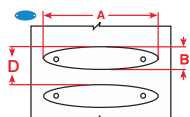

Diagram	Order Reference	Colour	Label Width A (mm)	Label Height B (mm)	Max. Lines of Text	Max. Characters per Line	Vertical Repeat D (mm)	Min. Wire Diameter (mm)	Max. Wire Diameter (mm)	Labels per Roll	Printer Ribbon Series	Printer Compatibility
B-7599: Polyethylene Tag												
	BM71R-1-7599-YL	Yellow	22.90	5.20	1	11	8.38	0.25	1.50	2500	R6200	BMP61, BMP71, M611
	BM71R-2-7599-YL	Yellow	23.00	5.20	1	8	8.38	0.75	2.60	2500	R6200	BMP61, BMP71, M611
	BM71R-3-7599-YL	Yellow	25.00	5.70	2	7	8.89	1.25	3.30	2500	R6200	BMP61, BMP71, M611
	BM71R-4-7599-YL	Yellow	26.00	7.00	2	7	10.82	1.75	4.60	2500	R6200	BMP61, BMP71, M611
	BM71R-5-7599-YL	Yellow	41.00	11.00	3	17	14.20	2.25	7.50	2500	R6200	BMP61, BMP71, M611

Order references beginning with "B" indicate bulk rolls.



See pages 49-53 for a detailed material index.

## Wire & cable marking

### B-7643 Halogen-free cable tag

- These cable markers are made of halogen-free polyurethane material.
- The markers are tough, imperishable and with a very high degree of mark permanence in almost any environment.

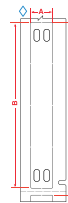

Diagram	Order Reference	Colour	Label Width A (mm)	Label Height B (mm)	Vertical Repeat D (mm)	Labels per Roll	Printer Ribbon Series	Printer Compatibility
<b>B-7643: Thermoplastic Polyether Polyurethane</b>								
◇	BM71-10x60-7643-BK	Black	10.00	60.00	65.09	250	R4400	BMP61, BMP71, M611
◇	BM71-10x75-7643-BK	Black	10.00	75.00	80.43	250	R4400-WT	BMP61, BMP71, M611
◇	BM71-10x60-7643-BL	Blue	10.00	60.00	65.09	250	M61-R6010	BMP61, BMP71, M611
◇	BM71-10x75-7643-BL	Blue	10.00	75.00	80.43	250	M61-R6010	BMP61, BMP71, M611
◇	BM71-10x60-7643-GN	Green	10.00	60.00	65.09	250	M61-R6010	BMP61, BMP71, M611
◇	BM71-10x75-7643-GN	Green	10.00	75.00	80.43	250	M61-R6010	BMP61, BMP71, M611
◇	BM71-10x60-7643-OR	Orange	10.00	60.00	65.09	250	M61-R6010	BMP61, BMP71, M611
◇	BM71-10x75-7643-OR	Orange	10.00	75.00	80.43	250	M61-R6010	BMP61, BMP71, M611
◇	BM71-10x60-7643-RD	Red	10.00	60.00	65.09	250	M61-R6010	BMP61, BMP71, M611
◇	BM71-10x75-7643-RD	Red	10.00	75.00	80.43	250	M61-R6010	BMP61, BMP71, M611
◇	BM71-10x60-7643-WT	White	10.00	60.00	65.09	250	M61-R6010	BMP61, BMP71, M611
◇	BM71-10x75-7643-WT	White	10.00	75.00	80.43	250	M61-R6010	BMP61, BMP71, M611
◇	M61-10x60-7643-WT	White	10.00	60.00	65.09	50	M61-R6010	BMP61, BMP71, M611
◇	M61-10x75-7643-WT	White	10.00	75.00	80.43	50	M61-R6010	BMP61, BMP71, M611
◇	BM71-10x60-7643-YL	Yellow	10.00	60.00	65.09	250	M61-R6010	BMP61, BMP71, M611
◇	BM71-10x75-7643-YL	Yellow	10.00	75.00	80.43	250	M61-R6010	BMP61, BMP71, M611
◇	M61-10x60-7643-YL	Yellow	10.00	60.00	65.09	50	M61-R6010	BMP61, BMP71, M611
◇	M61-10x75-7643-YL	Yellow	10.00	75.00	80.43	50	M61-R6010	BMP61, BMP71, M611
◇	BM71-15x75-7643-BK	Black	15.00	75.00	80.43	250	R4400-WT	BMP61, BMP71, M611
◇	BM71-15x75-7643-BL	Blue	15.00	75.00	80.43	250	M61-R6010	BMP61, BMP71, M611
◇	BM71-15x75-7643-GN	Green	15.00	75.00	80.43	250	M61-R6010	BMP61, BMP71, M611
◇	BM71-15x75-7643-OR	Orange	15.00	75.00	80.43	250	M61-R6010	BMP61, BMP71, M611
◇	BM71-15x75-7643-RD	Red	15.00	75.00	80.43	250	M61-R6010	BMP61, BMP71, M611
◇	BM71-15x75-7643-WT	White	15.00	75.00	80.43	250	M61-R6010	BMP61, BMP71, M611
◇	M61-15x75-7643-WT	White	15.00	75.00	80.43	50	M61-R6010	BMP61, BMP71, M611
◇	BM71-15x75-7643-YL	Yellow	15.00	75.00	80.43	250	M61-R6010	BMP61, BMP71, M611
◇	M61-15x75-7643-YL	Yellow	15.00	75.00	80.43	50	M61-R6010	BMP61, BMP71, M611
◇	BM71-25x75-7643-BK	Black	25.00	75.00	80.43	250	M61-R4410-WT	BMP61, BMP71, M611
◇	M61-25x75-7643-BK	Black	25.00	75.00	80.43	50	R4400-WT	BMP61, BMP71, M611
◇	BM71-25x75-7643-BL	Blue	25.00	75.00	80.43	250	M61-R6010	BMP61, BMP71, M611
◇	M61-25x75-7643-BL	Blue	25.00	75.00	80.43	50	M61-R6010	BMP61, BMP71, M611
◇	BM71-25x75-7643-GN	Green	25.00	75.00	80.43	250	M61-R6010	BMP61, BMP71, M611
◇	M61-25x75-7643-GN	Green	25.00	75.00	80.43	50	M61-R6010	BMP61, BMP71, M611
◇	BM71-25x75-7643-OR	Orange	25.00	75.00	80.43	250	M61-R6010	BMP61, BMP71, M611
◇	M61-25x75-7643-OR	Orange	25.00	75.00	80.43	50	M61-R6010	BMP61, BMP71, M611
◇	BM71-25x75-7643-RD	Red	25.00	75.00	80.43	250	M61-R6010	BMP61, BMP71, M611
◇	M61-25x75-7643-RD	Red	25.00	75.00	80.43	50	M61-R6010	BMP61, BMP71, M611
◇	BM71-25x75-7643-WT	White	25.00	75.00	80.43	250	M61-R6010	BMP61, BMP71, M611
◇	M61-25x75-7643-WT	White	25.00	75.00	80.43	50	M61-R6010	BMP61, BMP71, M611
◇	BM71-25x75-7643-YL	Yellow	25.00	75.00	80.43	250	M61-R6010	BMP61, BMP71, M611
◇	M61-25x75-7643-YL	Yellow	25.00	75.00	80.43	50	M61-R6010	BMP61, BMP71, M611



### Tear resistant cable markers

- These extremely tear resistant cable markers can be used for a variety of applications including identification of multiconductor cables, inventory and equipment.

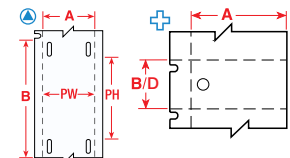
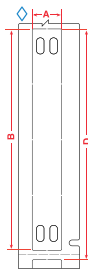

Diagram	Order Reference	Colour	Label Width A (mm)	Label Height B (mm)	Printable Area Width PW (mm)	Printable Area Height PH (mm)	Vertical Repeat D (mm)	Labels per Roll	Printer Ribbon Series	Printer Compatibility
<b>B-109: Polyethylene Tag</b>										
⊕	PTL-60-109	White	12.00	50.00	12.00	33.00	50.00	100	M61-R4310	BMP61, BMP71, M611
⊕	BM71-60-109	White	12.00	50.00	12.00	33.00	50.17	1000	M61-R4310	BMP61, BMP71, M611
⊕	PTL-12-109	White	19.05	76.20	-	-	76.20	100	M61-R4310	BMP61, BMP71, M611
⊕	BM71-12-109	White	19.05	76.20	17.78	52.07	76.20	1000	M61-R4310	BMP61, BMP71, M611
⊕	PTL-12-109-YL	Yellow	19.05	76.20	-	-	76.20	100	M61-R4310	BMP61, BMP71, M611
⊕	PTL-36-109	White	44.45	28.58	-	-	28.58	250	M61-R4310	BMP61, BMP71, M611

Order references beginning with "B" indicate bulk rolls.

## Wire & cable marking



### B-7598 Polyester cable tag

The B-7598 polyester tag is a general identification tag for cables exposed to extreme conditions. It requires cable ties to apply to cables with various diameters. Common applications for this cable tag material are:

- Identification of multi-conductor cables
- Identification of cables in mobile phone towers
- Identification of datacom or telecom cables in general
- General cable identification that must be extremely resistant

Diagram	Order Reference	Colour	Label Width A (mm)	Label Height B (mm)	Vertical Repeat D (mm)	Labels per Roll	Printer Ribbon Series	Printer Compatibility
<b>B-7598: Polyester Tag</b>								
◇	BM71-10x60-B7598-BK	Black	10.00	60.00	65.09	500	R4400-WT	BMP61, BMP71, M611
◇	BM71-10x75-B7598-BK	Black	10.00	75.00	80.43	250	R4400-WT	BMP61, BMP71, M611
◇	BM71-10x60-B7598-BL	Blue	10.00	60.00	65.09	500	M61-R6010	BMP61, BMP71, M611
◇	BM71-10x75-B7598-BL	Blue	10.00	75.00	80.43	250	M61-R6010	BMP61, BMP71, M611
◇	BM71-10x60-B7598-GN	Green	10.00	60.00	65.09	500	M61-R6010	BMP61, BMP71, M611
◇	BM71-10x75-B7598-GN	Green	10.00	75.00	80.43	250	M61-R6010	BMP61, BMP71, M611
◇	BM71-10x60-B7598-RD	Red	10.00	60.00	65.09	500	M61-R6010	BMP61, BMP71, M611
◇	BM71-10x75-B7598-RD	Red	10.00	75.00	80.43	250	M61-R6010	BMP61, BMP71, M611
◇	BM71-10x60-B7598-SV	Silver	10.00	60.00	65.09	500	M61-R6010	BMP61, BMP71, M611
◇	BM71-10x75-B7598-SV	Silver	10.00	75.00	80.43	250	M61-R6010	BMP61, BMP71, M611
◇	BM71-10x60-B7598-WT	White	10.00	60.00	65.09	500	M61-R6010	BMP61, BMP71, M611
◇	BM71-10x75-B7598-WT	White	10.00	75.00	80.43	250	M61-R6010	BMP61, BMP71, M611
◇	M61-10x60-B7598-WT	White	10.00	60.00	65.09	100	M61-R6010	BMP61, BMP71, M611
◇	M61-10x75-B7598-WT	White	10.00	75.00	80.43	100	M61-R6010	BMP61, BMP71, M611
◇	BM71-10x60-B7598-YL	Yellow	10.00	60.00	65.09	500	M61-R6010	BMP61, BMP71, M611
◇	BM71-10x75-B7598-YL	Yellow	10.00	75.00	80.43	250	M61-R6010	BMP61, BMP71, M611
◇	M61-10x60-B7598-YL	Yellow	10.00	60.00	65.09	100	M61-R6010	BMP61, BMP71, M611
◇	M61-10x75-B7598-YL	Yellow	10.00	75.00	80.43	100	M61-R6010	BMP61, BMP71, M611
◇	BM71-15x75-B7598-BK	Black	15.00	75.00	80.43	250	R4400-WT	BMP61, BMP71, M611
◇	BM71-15x75-B7598-BL	Blue	15.00	75.00	80.43	250	M61-R6010	BMP61, BMP71, M611
◇	BM71-15x75-B7598-GN	Green	15.00	75.00	80.43	250	M61-R6010	BMP61, BMP71, M611
◇	BM71-15x75-B7598-RD	Red	15.00	75.00	80.43	250	M61-R6010	BMP61, BMP71, M611
◇	BM71-15x75-B7598-SV	Silver	15.00	75.00	80.43	250	M61-R6010	BMP61, BMP71, M611
◇	BM71-15x75-B7598-WT	White	15.00	75.00	80.43	250	M61-R6010	BMP61, BMP71, M611
◇	M61-15x75-B7598-WT	White	15.00	75.00	80.43	100	M61-R6010	BMP61, BMP71, M611
◇	BM71-15x75-B7598-YL	Yellow	15.00	75.00	80.43	250	M61-R6010	BMP61, BMP71, M611
◇	M61-15x75-B7598-YL	Yellow	15.00	75.00	80.43	100	M61-R6010	BMP61, BMP71, M611
◇	BM71-25x75-B7598-BK	Black	25.00	75.00	80.43	250	R4400-WT	BMP61, BMP71, M611
◇	M61-25x75-B7598-BK	Black	25.00	75.00	80.43	100	R4400-WT	BMP61, BMP71, M611
◇	BM71-25x75-B7598-BL	Blue	25.00	75.00	80.43	250	M61-R6010	BMP61, BMP71, M611
◇	M61-25x75-B7598-BL	Blue	25.00	75.00	80.43	100	M61-R6010	BMP61, BMP71, M611
◇	BM71-25x75-B7598-GN	Green	25.00	75.00	80.43	250	M61-R6010	BMP61, BMP71, M611
◇	M61-25x75-B7598-GN	Green	25.00	75.00	80.43	100	M61-R6010	BMP61, BMP71, M611
◇	BM71-25x75-B7598-RD	Red	25.00	75.00	80.43	250	M61-R6010	BMP61, BMP71, M611
◇	M61-25x75-B7598-RD	Red	25.00	75.00	80.43	100	M61-R6010	BMP61, BMP71, M611
◇	BM71-25x75-B7598-SV	Silver	25.00	75.00	80.43	250	M61-R6010	BMP61, BMP71, M611
◇	M61-25x75-B7598-SV	Silver	25.00	75.00	80.43	100	M61-R6010	BMP61, BMP71, M611
◇	BM71-25x75-B7598-WT	White	25.00	75.00	80.43	250	M61-R6010	BMP61, BMP71, M611
◇	M61-25x75-B7598-WT	White	25.00	75.00	80.43	100	M61-R6010	BMP61, BMP71, M611
◇	BM71-25x75-B7598-YL	Yellow	25.00	75.00	80.43	250	M61-R6010	BMP61, BMP71, M611
◇	M61-25x75-B7598-YL	Yellow	25.00	75.00	80.43	100	M61-R6010	BMP61, BMP71, M611

Order references beginning with "B" indicate bulk rolls.

## Wire & cable marking

### B-145 Rigid polyethylene tag

- can be used to identify multiconductor cables, inventory, equipment, lockout, safety warning repair and work in progress
- has a precut hole for easy attachment
- non-adhesive
- extremely tear resistant
- standard and flame retardant (FR) version
- available in silver colour, in 2 sizes, with a matt finish
- can be offered in small roll (100) and in bulk (1000)

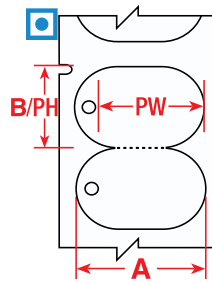

Diagram	Order Reference	Material	Colour	Label Width A (mm)	Label Height B (mm)	Labels per Row	Labels per Package	Ribbon Series	Printer Compatibility
	M61-144-145FR-GY	Polyethylene Tag	Grey	19.30	30.63	1	100	R6200	M611; BMP61
	M61-144-145-GY	Polyethylene Tag	Grey	19.30	30.63	1	100	R6200	M611; BMP61
	BM61-144-145FR-GY	Polyethylene Tag	Grey	19.30	30.63	1	1000	R6200	M611; BMP61
	BM61-144-145-GY	Polyethylene Tag	Grey	19.30	30.63	1	1000	R6200	M611; BMP61
	M61-145-145FR-GY	Polyethylene Tag	Grey	25.40	44.45	1	100	R6200	M611; BMP61
	M61-145-145-GY	Polyethylene Tag	Grey	25.40	44.45	1	100	R6200	M611; BMP61
	BM61-145-145FR-GY	Polyethylene Tag	Grey	25.40	44.45	1	1000	R6200	M611; BMP61
	BM61-145-145-GY	Polyethylene Tag	Grey	25.40	44.45	1	1000	R6200	M611; BMP61

Order references beginning with "B" indicate bulk rolls.



See pages 49-53 for a detailed material index.

## Wire & cable marking



### LAMINAT cable marking carriers

- LAMINAT carriers come with a strip to laminate text labels.
- Carriers are fixed with two cable ties on the cables and wires for permanent identification.
- The LAMINAT carriers can be used for any type of cable identification where permanency of the legend is crucial.



Pull the protective film backwards.



Place the label in the middle leaving space for sealing on all four sides of the label.



Seal the carrier by placing a finger on the film and pushing forward, thus rolling over the film and rolling off the silicon liner.



Always feed the cable ties from the top, thus bending down the LAMINAT carrier along the cable.

Diagram	Order Reference	Colour	Width A (mm)	Height B (mm)	Seal-up Area Width C (mm)	Seal-up Area Height D (mm)	Labels/Tapes Recommended	Quantity / Package
B-7644: Polypropylene Tag with Polyester Overlaminat								
	LC-65X13-B7644-0.1	Yellow	65.00	13.00	42.50	9.00	PTLTL-5-430/6 mm	100
	LC-71X9-B7644-0.1	Yellow	71.00	9.00	45.00	9.00	PTLTL-5-430/6 mm	100
	LC-103X15-B7644-0.1	Yellow	103.00	15.00	55.00	15.00	PTLTL-6-430/6 mm	100
	LC-128X15-B7644-0.1	Yellow	128.00	15.00	80.00	15.00	PTLTL-1-430/9 mm	100

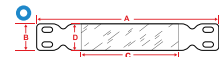

### LAMINAT Tags

- The LAMINAT tags (Manilla tags) are ideal for identification in tough environments including valves, instruments, motors and other industrial components.

Diagram	Order Reference	Colour	Width A (mm)	Height B (mm)	Seal-up Area Width C (mm)	Seal-up Area Height D (mm)	Labels/Tapes Recommended	Quantity / Package
B-7645: Polypropylene Tag with Polyester Overlaminat								
	LT-59X25-B7645-0.05	Yellow	59.00	25.00	43.00	25.00	PTLTL-4-430	50
	LT-59X25-B7645-WR-0.05	Yellow	59.00	25.00	43.00	25.00	PTLTL-4-430	50

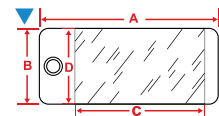

### Recommended labels for LAMINAT cable marking carriers

- Clear Polyester labels specifically designed to fit the LAMINAT cable marking carriers.

Diagram	Order Reference	Colour	Label Width A (mm)	Label Height B (mm)	Additional Features	Labels per Roll	Printer Ribbon Series	Printer Compatibility
B-430: Polyester								
	PTLTL-6-430	Transparent	11.00	49.00	Use with LC-103x15-B7644	150	M61-R6010	BMP61, BMP71, M611
	PTLTL-1-430	Transparent	11.00	74.00	Use with LC-128x150-B7644	100	M61-R6010	BMP61, BMP71, M611
	PTLTL-4-430	Transparent	37.00	21.00	Use with LT-59x25-B7645	300	M61-R6010	BMP61, BMP71, M611
	PTLTL-5-430	Transparent	39.00	5.00	Use with LC-65x13-B7644 and/or LC-71x9-B7644	300	M61-R6010	BMP61, BMP71, M611

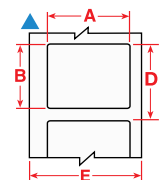

### Coloured Nylon Ties

- Perfect for colour coded applications.

Order Reference	Colour	Width (mm)	Length (mm)	Quantity
196283	Black	3.50	200.00	100
196311	Natural	3.50	200.00	100
196352	Yellow	3.50	200.00	100
196349	Blue	3.60	200.00	100
196350	Green	3.60	200.00	100
196351	Red	3.60	200.00	100



## Wire & cable marking

### DuraSleeve inserts

- Brady DuraSleeve printable inserts create a durable legend.
- Tags and inserts easily slide into the clear carriers.
- The legend can be changed before or after termination.

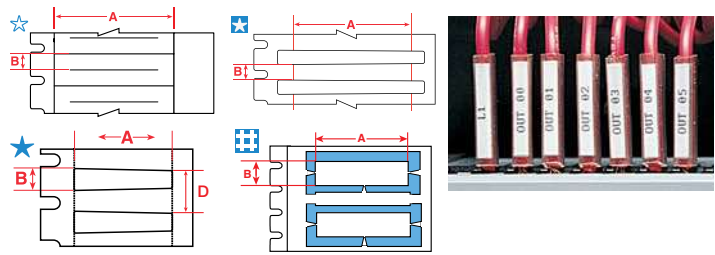

Diagram	Order Reference	Colour	Label Width A (mm)	Label Height B (mm)	Vertical Repeat D (mm)	Labels per Roll	Printer Ribbon Series	Printer Compatibility
<b>B-390: Rigid Insert</b>								
	PTDS-15-390	White	15.00	4.14	4.14	300	M61-R6610	BMP61, BMP71, M611
	BPTDS-15-390	White	15.00	4.14	-	3000	M61-R6610	BMP61, BMP71, M611
	PTDS-30-390	White	30.00	4.14	4.14	300	M61-R6610	BMP61, BMP71, M611
	BPTDS-30-390	White	30.00	4.14	-	3000	M61-R6610	BMP61, BMP71, M611
<b>B-7597: Polyethylene Tag</b>								
	PTDSU-10-7597	White	10.00	4.20	4.20	1500	R4300	BMP61, BMP71, M611
	PTDSU-10-7597-YL	Yellow	10.00	4.20	4.20	1500	R6000	BMP61, BMP71, M611
	PTDSU-15-7597	White	15.00	4.20	4.20	1500	R4300	BMP61, BMP71, M611
	PTDSU-15-7597-YL	Yellow	15.00	4.20	4.20	1500	R6000	BMP61, BMP71, M611
	PTDSU-30-7597	White	30.00	4.10	4.10	1500	R4300	BMP61, BMP71, M611
	PTDSU-30-7597-YL	Yellow	30.00	4.10	4.10	1500	R6000	BMP61, BMP71, M611
<b>B-7696: Vinyl Tag</b>								
	BM71D-1-7696	White	10.00	4.40	7.56	2500	M61-R6010	BMP61, BMP71, M611
	BM71D-1-7696-YL	Yellow	10.00	4.40	7.56	2500	M61-R6010	BMP61, BMP71, M611
	PTLRDS-12x4,4-7696	White	12.00	4.40	7.56	250	M61-R6010	BMP61, BMP71, M611
	BM71D-2-7696	White	12.00	4.40	7.56	2500	M61-R6010	BMP61, BMP71, M611
	BM71D-2-7696-YL	Yellow	12.00	4.40	7.56	2500	M61-R6010	BMP61, BMP71, M611
	PTLRDS-16x4,4-7696	White	16.00	4.40	7.56	250	M61-R6010	BMP61, BMP71, M611
	PTLRDS-16x4,4-7696-YL	Yellow	16.00	4.40	7.56	250	M61-R6010	BMP61, BMP71, M611
	BM71D-3-7696	White	16.00	4.40	7.56	2500	M61-R6010	BMP61, BMP71, M611
	BM71D-3-7696-YL	Yellow	16.00	4.40	7.56	5000	M61-R6010	BMP61, BMP71, M611
	PTLRDS-23x4,4-7696	White	23.00	4.40	7.56	250	M61-R6010	BMP61, BMP71, M611
	BM71D-4-7696	White	23.00	4.40	7.56	2500	M61-R6010	BMP61, BMP71, M611
	BM71D-4-7696-YL	Yellow	23.00	4.40	7.56	2500	M61-R6010	BMP61, BMP71, M611
	PTLRDS-30x4,4-7696	White	30.00	4.40	7.56	250	M61-R6010	BMP61, BMP71, M611
	PTLRDS-30x4,4-7696-YL	Yellow	30.00	4.40	7.56	250	M61-R6010	BMP61, BMP71, M611
	BM71D-5-7696	White	30.00	4.40	7.56	2500	M61-R6010	BMP61, BMP71, M611
	BM71D-5-7696-YL	Yellow	30.00	4.40	7.56	5000	M61-R6010	BMP61, BMP71, M611
<b>B-7697: Polyester Tag</b>								
	BM61D-1-7697-WT	White	10.00	4.40	7.58	2500	R4300, R6200	BMP61, BMP71, M611
	BM61D-2-7697-WT	White	12.00	4.40	7.58	2500	R4300, R6200	BMP61, BMP71, M611
	BM61D-3-7697-WT	White	16.00	4.40	7.58	2500	R4300, R6200	BMP61, BMP71, M611
	BM61D-4-7697-WT	White	23.00	4.40	7.58	2500	R4300, R6200	BMP61, BMP71, M611
	BM61D-5-7697-WT	White	30.00	4.40	7.58	2500	R4300, R6200	BMP61, BMP71, M611

Order references beginning with "B" indicate bulk rolls.

### DuraSleeve tag carrier

DuraSleeve tag carriers are produced in transparent PVC. The special shape of the carrier allows it to adapt to cables of various diameters. There are several sizes of carriers which cater for cables with external diameters from 1.30 mm up to 15 mm.

- Temperature range: -40 °C to 60 °C
- Material: PVC

Please contact your local Brady representative to identify and select the most appropriate carrier for your individual application.



## Component & equipment marking



### EPREP: Engraved Plate REplacement Labels

- Brady EPREP labels are innovative labels specifically designed to replace engraved and plotted plates for identification of electrical components, electrical cabinets, push buttons, patch panels etc.

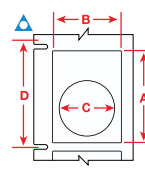
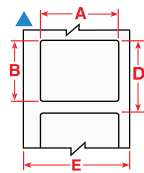

Roll mounted



Fanfolded



Bulk roll

Diagram	Order Reference	Colour	Label Width A (mm)	Label Height B (mm)	Hole Diameter C (mm)	Vertical Repeat D (mm)	Labels per Roll	Layout	Printer Ribbon Series	Printer Compatibility
B-7593: Polyethylene Foam Laminate Polyester										
▲	M61EP-06-7593-BK	Black	15.00	45.00	-	68.26	300	Fan-folded	M61-R4410-WT	M611; BMP61
▲	M61EP-06-7593-RD	Red	15.00	45.00	-	68.26	300	Fan-folded	M61-R4410-WT	M611; BMP61
▲	BM61E-06-7593-SV	Silver	15.00	45.00	-	68.26	450	Bulk Roll	M61-R6010	M611; BMP61
▲	BM61E-06-7593-WT	White	15.00	45.00	-	68.26	450	Bulk Roll	M61-R6010	M611; BMP61
▲	M61EP-06-7593-YL	Yellow	15.00	45.00	-	68.26	300	Fan-folded	M61-R6010	M611; BMP61
▲	M61EP-07-7593-BK	Black	18.00	35.00	-	45.00	300	Fan-folded	M61-R4410-WT	M611; BMP61
▲	M61EP-07-7593-SV	Silver	18.00	35.00	-	45.00	300	Fan-folded	M61-R6010	M611; BMP61
▲	M61EP-07-7593-WT	White	18.00	35.00	-	45.00	300	Fan-folded	M61-R6010	M611; BMP61
▲	M61EP-07-7593-YL	Yellow	18.00	35.00	-	45.00	300	Fan-folded	M61-R6010	M611; BMP61
▲	M61EP-08-7593-BK	Black	19.00	48.00	-	71.00	300	Fan-folded	M61-R4410-WT	M611; BMP61
▲	M61EP-08-7593-SV	Silver	19.00	48.00	-	71.00	300	Fan-folded	M61-R6010	M611; BMP61
▲	M61EP-08-7593-WT	White	19.00	48.00	-	71.00	300	Fan-folded	M61-R6010	M611; BMP61
▲	M61EP-08-7593-YL	Yellow	19.00	48.00	-	71.00	300	Fan-folded	M61-R6010	M611; BMP61
▲	PTLEP-09-7593-WT	White	25.00	75.00	-	78.17	100	Fan-folded	M61-R6010	BMP61, BMP71, M611
▲	PTLEP-09-7593-YL	Yellow	25.00	75.00	-	78.17	100	Fan-folded	M61-R6010	BMP61, BMP71, M611
▲	PTLEP-10-7593-WT	White	25.00	100.00	-	103.17	100	Fan-folded	M61-R6010	BMP61, BMP71, M611
▲	PTLEP-10-7593-YL	Yellow	25.00	100.00	-	103.17	100	Fan-folded	M61-R6010	BMP61, BMP71, M611
▲	PTLEP-01-7593-BK	Black	27.00	8.00	-	11.17	250	Roll Mounted	M61-R4410-WT	BMP61, BMP71, M611
▲	PTLEP-01-7593-GR	Green	27.00	8.00	-	11.17	250	Roll Mounted	M61-R4410-WT	BMP61, BMP71, M611
▲	PTLEP-01-7593-RD	Red	27.00	8.00	-	11.17	250	Roll Mounted	M61-R4410-WT	BMP61, BMP71, M611
▲	PTLEP-01-7593-SV	Silver	27.00	8.00	-	11.17	250	Roll Mounted	M61-R6010	BMP61, BMP71, M611
▲	PTLEP-01-7593-WT	White	27.00	8.00	-	11.17	250	Roll Mounted	M61-R6010	BMP61, BMP71, M611
▲	PTLEP-01-7593-YL	Yellow	27.00	8.00	-	11.17	250	Roll Mounted	M61-R6010	BMP61, BMP71, M611
▲	PTLEP-02-7593-BK	Black	27.00	12.50	-	15.67	250	Roll Mounted	M61-R4410-WT	BMP61, BMP71, M611
▲	PTLEP-02-7593-GR	Green	27.00	12.50	-	15.67	250	Roll Mounted	M61-R4410-WT	BMP61, BMP71, M611
▲	PTLEP-02-7593-RD	Red	27.00	12.50	-	15.67	250	Roll Mounted	M61-R4410-WT	BMP61, BMP71, M611
▲	PTLEP-02-7593-SV	Silver	27.00	12.50	-	15.67	250	Roll Mounted	M61-R6010	BMP61, BMP71, M611
▲	PTLEP-02-7593-WT	White	27.00	12.50	-	15.67	250	Roll Mounted	M61-R6010	BMP61, BMP71, M611
▲	PTLEP-02-7593-YL	Yellow	27.00	12.50	-	15.67	250	Roll Mounted	M61-R6010	BMP61, BMP71, M611
▲	PTLEP-03-7593-BK	Black	27.00	15.00	-	18.17	150	Roll Mounted	M61-R4410-WT	BMP61, BMP71, M611
▲	PTLEP-03-7593-RD	Red	27.00	15.00	-	18.17	150	Roll Mounted	M61-R4410-WT	BMP61, BMP71, M611
▲	PTLEP-03-7593-SV	Silver	27.00	15.00	-	18.17	150	Roll Mounted	M61-R6010	BMP61, BMP71, M611
▲	PTLEP-03-7593-WT	White	27.00	15.00	-	18.17	150	Roll Mounted	M61-R6010	BMP61, BMP71, M611
▲	PTLEP-03-7593-YL	Yellow	27.00	15.00	-	18.17	150	Roll Mounted	M61-R6010	BMP61, BMP71, M611
▲	PTLEP-04-7593-BK	Black	27.00	18.00	-	21.17	150	Roll Mounted	M61-R4410-WT	BMP61, BMP71, M611
▲	PTLEP-04-7593-RD	Red	27.00	18.00	-	21.17	150	Roll Mounted	M61-R4410-WT	BMP61, BMP71, M611
▲	PTLEP-04-7593-SV	Silver	27.00	18.00	-	21.17	150	Roll Mounted	M61-R6010	BMP61, BMP71, M611
▲	PTLEP-04-7593-WT	White	27.00	18.00	-	21.17	150	Roll Mounted	M61-R6010	BMP61, BMP71, M611
▲	PTLEP-04-7593-YL	Yellow	27.00	18.00	-	21.17	150	Roll Mounted	M61-R6010	BMP61, BMP71, M611
△	PTLEP-05-7593-BK	Black	30.00	40.00	24.00	43.17	100	Fan-folded	M61-R4410-WT	BMP61, BMP71, M611
△	PTLEP-05-7593-GR	Green	30.00	40.00	24.00	43.17	100	Fan-folded	M61-R4410-WT	BMP61, BMP71, M611
△	PTLEP-05-7593-RD	Red	30.00	40.00	24.00	43.17	100	Fan-folded	M61-R4410-WT	BMP61, BMP71, M611
△	PTLEP-05-7593-SV	Silver	30.00	40.00	24.00	43.17	100	Fan-folded	M61-R6010	BMP61, BMP71, M611
△	PTLEP-05-7593-WT	White	30.00	40.00	24.00	43.17	100	Fan-folded	M61-R6010	BMP61, BMP71, M611
△	PTLEP-05-7593-YL	Yellow	30.00	40.00	24.00	43.17	100	Fan-folded	M61-R6010	BMP61, BMP71, M611

Order references beginning with "B" indicate bulk rolls.

## Component & equipment marking

### Terminal block markers

- Repositionable vinyl cloth marker with a firm adhesive offering excellent holding power, but can be easily removed and reapplied.

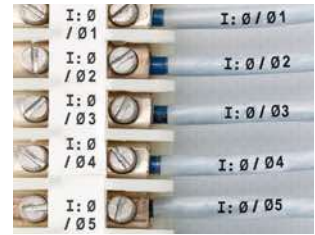
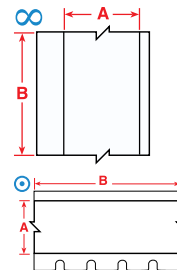

Diagram	Order Reference	Colour	Label Width A (mm)	Label Length B (m)	Labels per Roll	Printer Ribbon Series	Printer Compatibility
B-498: Vinyl Cloth							
	PTLTB-498-240	White	6.09	9.14	1	M61-R6210	BMP61, BMP71, M611
	M61C-240-498	White	6.10	9.14	1	M61-R6210	BMP61, M611
	PTLTB-498-318	White	8.08	9.14	1	M61-R6210	BMP61, BMP71, M611
	M61C-318-498	White	8.08	9.14	1	M61-R6210	BMP61, M611
	PTLTB-498-375	White	9.53	9.14	1	M61-R6210	BMP61, BMP71, M611
	M61C-375-498	White	9.53	9.14	1	M61-R6210	BMP61, M611



### General electrical component marking

- Nylon cloth marker with a firm adhesive offering excellent holding power in harsh environments.

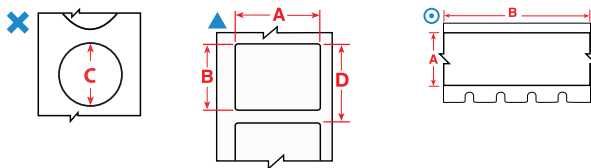

Diagram	Order Reference	Colour	Label Width A (mm)	Label Height B (mm)	Label Length B (m)	Diameter C (mm)	Vertical Repeat D (mm)	Max. Characters per Line	Max. Lines of Text	Labels per Roll	Printer Ribbon Series	Printer Compatibility
B-498: Vinyl Cloth												
	BM71C-240-498	White	6.10	-	83.80	-	-	5	-	1	M61-R6200	BMP61, BMP71, M611
	BM71C-318-498	White	8.08	-	83.80	-	-	7	-	1	M61-R6200	BMP61, BMP71, M611
	BM71C-375-498	White	9.53	-	83.80	-	-	7	-	1	M61-R6200	BMP61, BMP71, M611
B-499: Nylon Cloth												
	PTL-82-499	White	-	-	-	9.53	12.70	8	3	500	M61-R4310	BMP61, BMP71, M611
	PTL-83-499	White	-	-	-	12.70	15.87	11	1	500	M61-R4310	BMP61, BMP71, M611
	PTL-83-499-YL	Yellow	-	-	-	12.70	15.87	11	1	500	M61-R4310	BMP61, BMP71, M611
	PTL-82-499-YL	Yellow	-	-	-	9.53	12.70	8	3	500	M61-R4310	BMP61, BMP71, M611
	PTL-67-499-YL	Yellow	15.00	9.00	-	-	12.17	13	2	750	M61-R4310	BMP61, BMP71, M611
	BPTL-67-499-YL	Yellow	15.00	9.00	-	-	12.17	13	2	7500	M61-R4310	BMP61, M611
	PTL-153-499-YL	Yellow	16.00	5.00	-	-	8.17	15	1	750	M61-R4310	BMP61, BMP71, M611
	PTL-47-499-YL	Yellow	20.00	8.00	-	-	11.17	18	2	750	M61-R4310	BMP61, BMP71, M611

Order references beginning with "B" indicate bulk rolls.

**i** See pages 49-53 for a detailed material index.

## Component marking



### Workstation labels

- A variety of durable and resistant materials to label your workstation.

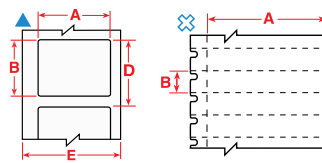

Diagram	Order Reference	Colour	Label Width A (mm)	Label Height B (mm)	Vertical Repeat D (mm)	Labels per Roll	Printer Ribbon Series	Printer Compatibility
<b>B-412: Polypropylene Tag</b>								
⊗	PTL-40-412	White	49.23	9.53	12.70	750	M61-R6210	BMP61, BMP71, M611
⊗	BM71-40-412	White	49.23	9.53	9.53	5000	R6200	BMP61, BMP71, M611
<b>B-422: Polyester</b>								
⊗	PTL-39-422	White	9.53	15.24	-	750	M61-R6010	BMP61, BMP71, M611
▲	PTL-44-422	White	12.70	9.53	12.70	500	M61-R6010	BMP61, BMP71, M611
▲	PTL-7-422	White	12.70	12.70	15.87	500	M61-R6010	BMP61, BMP71, M611
▲	PTL-17-422	White	25.40	12.70	15.87	500	M61-R6010	BMP61, BMP71, M611
▲	PTL-16-422	White	25.40	9.53	12.70	500	M61-R6010	BMP61, BMP71, M611
▲	PTL-29-422	White	38.10	12.70	15.88	500	M61-R6010	BMP61, BMP71, M611
<b>B-430: Polyester</b>								
▲	PTL-71-430	Clear	8.89	5.08	8.25	750	M61-R6010	BMP61, BMP71, M611
⊗	PTL-39-430	Clear	9.53	15.24	-	750	M61-R6010	BMP61, BMP71, M611
▲	PTL-7-430	Clear	12.70	12.70	15.87	500	M61-R6010	BMP61, BMP71, M611
▲	PTL-44-430	Clear	12.70	9.53	12.70	500	M61-R6010	BMP61, BMP71, M611
▲	PTL-17-430	Clear	25.40	12.70	15.87	500	M61-R6010	BMP61, BMP71, M611
▲	PTL-16-430	Clear	25.40	9.53	12.70	500	M61-R6010	BMP61, BMP71, M611
▲	PTL-45-430	Clear	38.10	9.53	12.70	500	M61-R6010	BMP61, BMP71, M611
▲	PTL-29-430	Clear	38.10	12.70	15.88	500	M61-R6010	BMP61, BMP71, M611

Order references beginning with "B" indicate bulk rolls.



### Patch panel labels

- Create a fully-formatted serialised punch block label to fit your equipment.
- Label your ports, jack and outlets with adhesive labels or slide-in strips.

Diagram	Order Reference	Colour	Label Width A (mm)	Label Height B (mm)	Label Length B (m)	Vertical Repeat D (mm)	Labels per Roll	Printer Ribbon Series	Printer Compatibility
<b>B-412: Polypropylene Tag</b>									
◆	PTL-55-412	White	5.84	-	15.24	-	1	M61-R6210	BMP61, BMP71, M611
◆	PTL-56-412	White	9.53	-	15.24	-	1	M61-R6210	BMP61, BMP71, M611
◆	PTL-57-412	White	12.70	-	15.24	-	1	M61-R6210	BMP61, BMP71, M611
◆	PTL-58-412	White	13.59	-	15.24	-	1	M61-R6210	BMP61, BMP71, M611
◆	PTL-59-412	White	19.94	-	15.24	-	1	M61-R6210	BMP61, BMP71, M611
<b>B-422: Polyester</b>									
⊗	PTL-39-422	White	9.53	15.24	-	-	750	M61-R6010	BMP61, BMP71, M611
▲	PTL-7-422	White	12.70	12.70	-	15.87	500	M61-R6010	BMP61, BMP71, M611
⊙	PTLTB-8-422	White	8.00	-	15.00	-	1	M61-R6010	BMP61, BMP71, M611
∞	PTL-46-422	White	9.53	-	15.24	-	1	M61-R6010	BMP61, BMP71, M611
∞	PTL-8-422	White	12.70	-	15.24	-	1	M61-R6010	BMP61, BMP71, M611
<b>B-428: Metallised Polyester</b>									
⊙	M61C-500-428	Silver	12.70	-	15.24	-	1	M61-R4310	M611; BMP61
<b>B-430: Polyester</b>									
▲	PTL-7-430	Clear	12.70	12.70	-	15.87	500	M61-R6010	BMP61, BMP71, M611
⊙	M61C-375-430	Clear	9.52	-	15.24	-	1	M61-R6010	M611; BMP61
⊗	PTL-39-430	Clear	9.53	15.24	15.24	-	750	M61-R6010	BMP61, BMP71, M611
∞	PTL-46-430	Clear	9.53	8.00	15.24	-	1	M61-R6010	BMP61, BMP71, M611
∞	PTL-8-430	Clear	12.70	-	15.24	-	1	M61-R6010	BMP61, BMP71, M611
⊙	M61C-500-430	Clear	12.70	-	15.24	-	1	M61-R6010	M611; BMP61
<b>B-432: Polyester</b>									
▲	PTL-10-432	Clear	19.05	6.35	-	9.53	750	M61-R6010	BMP61, BMP71, M611
∞	PTL-8-432	Clear	12.70	-	15.24	-	1	M61-R6010	BMP61, BMP71, M611
<b>B-7551: Polyester</b>									
⊙	PTLTB-5-7551	Clear	4.50	-	15.00	-	1	M61-R6010	BMP61, BMP71, M611
⊙	PTLTB-8-7551	Clear	8.00	-	15.00	-	1	M61-R6010	BMP61, BMP71, M611

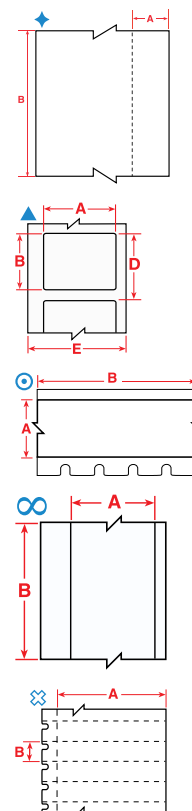

## Asset & component marking

### Racks, panels & general datacom identification

- Durable materials with permanent adhesive in a variety of sizes for marking racks, bays, frames, slots and other voice/data equipment.

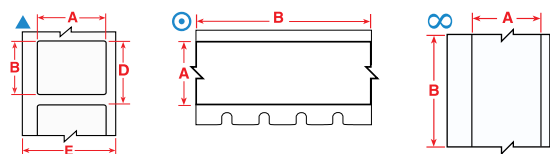

Diagram	Order Reference	Colour	Label Width A (mm)	Label Height B (mm)	Label Length B (m)	Vertical Repeat D (mm)	Labels per Roll	Printer Ribbon Series	Printer Compatibility
<b>B-422: Polyester</b>									
▲	BM71-20-422	White	25.40	50.80	-	53.98	1000	R6000HF	M611, BMP61, BMP71
▲	PTL-20-422	White	50.80	25.40	-	28.57	100	M61-R6010	M611, BMP61, BMP71
◎	M61C-375-422	White	9.52	-	15.24	-	1	M61-R6010	M611; BMP61
◎	M61C-475-422	White	12.06	-	15.24	-	1	M61-R6010	M611; BMP61
∞	PTL-8-422	White	12.70	-	15.24	-	1	M61-R6010	M611, BMP61, BMP71
◎	M61C-500-422	White	12.70	-	15.24	-	1	M61-R6010	M611; BMP61
◎	M61C-625-422	White	15.88	-	15.24	-	1	M61-R6010	M611; BMP61
∞	PTL-42-422	White	25.40	-	15.24	-	1	M61-R6010	M611, BMP61, BMP71
<b>B-423: Polyester</b>									
▲	PTL-10-423	White	19.05	6.35	-	9.53	750	M61-R6010	M611, BMP61, BMP71
▲	M61-30-423	White	38.10	19.05	-	-	250	M61-R6010	M611, BMP61, BMP71
▲	M61-52-423	White	48.26	15.24	-	-	250	M61-R6010	M611, BMP61, BMP71
◎	M61C-500-423	White	12.70	-	15.24	-	1	M61-R6010	M611; BMP61
<b>B-428: Metallised Polyester</b>									
◎	M61C-500-428	Silver	12.70	-	15.24	-	1	M61-R4310	M611; BMP61
<b>B-430: Polyester</b>									
▲	M61-22-430	Clear	25.40	76.20	-	-	100	M61-R6010	M611, BMP61, BMP71
▲	PTL-28-430	Clear	38.10	6.35	-	9.53	750	M61-R6010	M611, BMP61, BMP71
▲	M61-30-430	Clear	38.10	19.05	-	-	250	M61-R6010	M611, BMP61, BMP71
▲	M61-78-430	Clear	48.26	25.40	-	-	250	M61-R6010	M611, BMP61, BMP71
▲	M61-37-430	Clear	48.26	76.20	-	-	100	M61-R6010	M611, BMP61, BMP71
▲	M61-52-430	Clear	48.26	15.24	-	-	250	M61-R6010	M611, BMP61, BMP71
◎	M61C-375-430	Clear	9.52	-	15.24	-	1	M61-R6010	M611; BMP61
∞	PTL-8-430	Clear	12.70	-	15.24	-	1	M61-R6010	M611, BMP61, BMP71
◎	M61C-500-430	Clear	12.70	-	15.24	-	1	M61-R6010	M611; BMP61
∞	PTL-42-430	Clear	25.40	-	15.24	-	1	M61-R6010	M611, BMP61, BMP71
∞	PTL-43-430	Clear	48.26	-	15.24	-	1	M61-R6010	M611, BMP61, BMP71
<b>B-432: Polyester</b>									
▲	PTL-11-432	Clear	19.05	12.70	-	15.88	500	M61-R6010	M611, BMP61, BMP71
∞	PTL-101-432	Clear	6.35	-	15.24	-	1	M61-R6010	M611, BMP61, BMP71
∞	PTL-8-432	Clear	12.70	-	15.24	-	1	M61-R6010	M611, BMP61, BMP71
∞	PTL-42-432	Clear	25.40	-	15.24	-	1	M61-R6010	M611, BMP61, BMP71
∞	PTL-43-432	Clear	48.26	-	15.24	-	1	M61-R6010	M611, BMP61, BMP71
<b>B-483: Polyester</b>									
∞	PTL-101-483	White	6.35	-	15.24	-	1	M61-R6010	M611, BMP61, BMP71
◎	M61C-500-483	White	12.70	-	15.24	-	1	M61-R6010	M611; BMP61
∞	PTL-42-483	White	25.40	-	15.24	-	1	M61-R6010	M611, BMP61, BMP71
∞	PTL-43-483	White	48.26	-	15.24	-	1	M61-R6010	M611, BMP61, BMP71

Order references beginning with "B" indicate bulk rolls.

### Paper labels

- Economical choice for light duty general identification.
- White finish and matt topcoat.
- Excellent contrast and smear resistance for barcode printing.



Diagram	Order Reference	Colour	Label Width A (mm)	Label Height B (mm)	Vertical Repeat D (mm)	Labels per Roll	Printer Ribbon Series	Printer Compatibility
<b>B-424: Paper</b>								
▲	PTL-80-424	White	22.86	19.05	22.22	250	M61-R4310	M611, BMP61
▲	PTL-22-424	White	25.40	76.20	79.37	100	M61-R4310	M611, BMP61
▲	BM71-20-424	White	25.40	50.80	53.98	1000	R4300	M611, BMP61
▲	PTL-37-424	White	48.26	76.20	79.37	100	M61-R4310	M611, BMP61
▲	PTL-38-424	White	48.26	101.60	104.77	100	M61-R4310	M611, BMP61
▲	PTL-20-424	White	50.80	25.40	28.57	100	M61-R4310	M611, BMP61

Order references beginning with "B" indicate bulk rolls.

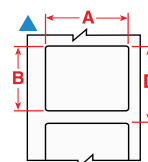

See pages 49-53 for a detailed material index.

## Asset & component marking



### Rating and name plate labels

- Choose from several materials with aggressive adhesives for use in commercial/ industrial applications, including low surface energy and textured surfaces.

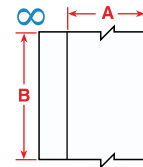
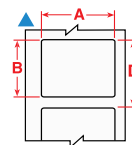
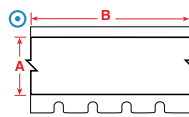
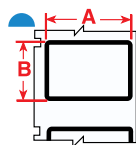

Diagram	Order Reference	Colour	Label Width A (mm)	Label Height B (mm)	Label Length B (m)	Vertical Repeat D (mm)	Labels per Roll	Printer Ribbon Series	Printer Compatibility
<b>B-422: Polyester</b>									
⊙	M61C-375-422	White	9.52	-	15.24	-	1	M61-R6010	M611; BMP61
∞	PTL-46-422	White	9.53	-	15.24	-	1	M61-R6010	BMP61, BMP71, M611
⊙	M61C-475-422	White	12.06	-	15.24	-	1	M61-R6010	M611; BMP61
∞	PTL-8-422	White	12.70	-	15.24	-	1	M61-R6010	BMP61, BMP71, M611
⊙	M61C-500-422	White	12.70	-	15.24	-	1	M61-R6010	M611; BMP61
⊙	M61C-625-422	White	15.88	-	15.24	-	1	M61-R6010	M611; BMP61
∞	PTL-42-422	White	25.40	-	15.24	-	1	M61-R6010	BMP61, BMP71, M611
∞	PTL-43-422	White	48.26	-	15.24	-	1	M61-R6010	BMP61, BMP71, M611
<b>B-423: Polyester</b>									
▲	BM71-19-423	White	25.40	25.40	-	28.58	2500	M61-R6010	BMP61, BMP71, M611
▲	PTL-24-423-BK	White with 1.6 mm Black Border	28.70	12.70	-	15.87	500	M61-R6010	BMP61, BMP71, M611
⊙	M61C-500-423	White	12.70	-	15.24	-	1	M61-R6010	M611; BMP61
<b>B-428: Metallised Polyester</b>									
▲	PTL-15-428	Silver	25.40	6.99	-	10.16	750	M61-R4310	BMP61, BMP71, M611
▲	PTL-17-428	Silver	25.40	12.70	-	15.87	500	M61-R4310	BMP61, BMP71, M611
▲	PTL-22-428	Silver	25.40	76.20	-	79.37	100	M61-R4310	BMP61, BMP71, M611
▲	BM71-17-428	Silver	25.40	12.70	-	15.88	5000	M61-R4300	BMP61, BMP71, M611
▲	BM71-20-428	Silver	25.40	50.80	-	53.98	1000	M61-R4300	BMP61, BMP71, M611
▲	PTL-24-428-BK	Silver with 1.6 mm Black Border	28.70	12.70	-	15.87	500	M61-R4310	BMP61, BMP71, M611
▲	PTL-26-428	Silver	31.75	69.85	-	73.02	100	M61-R4310	BMP61, BMP71, M611
▲	PTL-29-428	Silver	38.10	12.70	-	15.88	500	M61-R4310	BMP61, BMP71, M611
▲	PTL-37-428	Silver	48.26	76.20	-	79.37	100	M61-R4310	BMP61, BMP71, M611
▲	PTL-38-428	Silver	48.26	101.60	-	104.77	100	M61-R4310	BMP61, BMP71, M611
▲	PTL-20-428	Silver	50.80	25.40	-	28.57	100	M61-R4310	BMP61, BMP71, M611
∞	PTL-8-428	Silver	12.70	-	15.24	-	1	M61-R4310	BMP61, BMP71, M611
⊙	M61C-500-428	Silver	12.70	-	15.24	-	1	M61-R4310	M611; BMP61
<b>B-432: Polyester</b>									
▲	PTL-10-432	Clear	19.05	6.35	-	9.53	750	M61-R6010	BMP61, BMP71, M611
▲	PTL-11-432	Clear	19.05	12.70	-	15.88	500	M61-R6010	BMP61, BMP71, M611
▲	PTL-17-432	Clear	25.40	12.70	-	15.87	500	M61-R6010	BMP61, BMP71, M611
∞	PTL-101-432	Clear	6.35	-	15.24	-	1	M61-R6010	BMP61, BMP71, M611
∞	PTL-8-432	Clear	12.70	-	15.24	-	1	M61-R6010	BMP61, BMP71, M611
∞	PTL-42-432	Clear	25.40	-	15.24	-	1	M61-R6010	BMP61, BMP71, M611
∞	PTL-43-432	Clear	48.26	-	15.24	-	1	M61-R6010	BMP61, BMP71, M611
<b>B-435: Metallised Polyester</b>									
▲	PTL-16-435	Silver	25.40	9.53	-	12.70	500	M61-R6010	BMP61, BMP71, M611
▲	PTL-17-435	Silver	25.40	12.70	-	15.87	500	M61-R6010	BMP61, BMP71, M611
▲	PTL-29-435	Silver	38.10	12.70	-	15.88	500	M61-R6010	BMP61, BMP71, M611
▲	PTL-30-435	Silver	38.10	19.05	-	22.22	250	M61-R6010	BMP61, BMP71, M611
▲	PTL-31-435	Silver	38.10	25.40	-	28.57	250	M61-R6010	BMP61, BMP71, M611
▲	PTL-32-435	Silver	38.10	38.10	-	3.17	250	M61-R6010	BMP61, BMP71, M611
▲	PTL-37-435	Silver	48.26	76.20	-	79.37	100	M61-R6010	BMP61, BMP71, M611
▲	PTL-38-435	Silver	48.26	101.60	-	104.77	100	M61-R6010	BMP61, BMP71, M611
▲	PTL-20-435	Silver	50.80	25.40	-	28.57	100	M61-R6010	BMP61, BMP71, M611
∞	PTL-43-435	Silver	48.26	-	15.24	-	1	M61-R6010	BMP61, BMP71, M611

>>

Asset & component marking

Rating and name plate labels (continued)

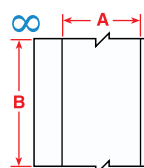
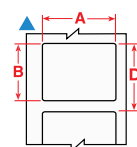
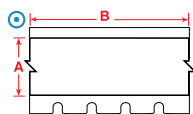
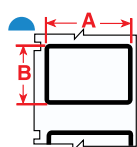

Diagram	Order Reference	Colour	Label Width A (mm)	Label Height B (mm)	Label Length B (m)	Vertical Repeat D (mm)	Labels per Roll	Printer Ribbon Series	Printer Compatibility
<b>B-483: Polyester</b>									
▲	PTL-61-483	White	12.70	50.80	-	53.97	100	M61-R6010	BMP61, BMP71, M611
▲	PTL-62-483	White	19.05	101.60	-	104.77	50	M61-R6010	BMP61, BMP71, M611
▲	PTL-63-483	White	19.05	203.20	-	206.37	50	M61-R6010	BMP61, BMP71, M611
▲	PTL-23-483	White	25.40	101.60	-	104.77	100	M61-R6010	BMP61, BMP71, M611
▲	PTL-17-483	White	25.40	12.70	-	15.87	500	M61-R6010	BMP61, BMP71, M611
▲	PTL-19-483	White	25.40	25.40	-	28.57	250	M61-R6010	BMP61, BMP71, M611
▲	PTL-16-483	White	25.40	9.53	-	12.70	500	M61-R6010	BMP61, BMP71, M611
◐	PTL-24-483-BK	White with 1.6 mm Black Border	28.70	12.70	-	15.87	500	M61-R6010	BMP61, BMP71, M611
▲	PTL-65-483	White	34.93	25.40	-	28.57	250	M61-R6010	BMP61, BMP71, M611
▲	PTL-29-483	White	38.10	12.70	-	15.88	500	M61-R6010	BMP61, BMP71, M611
▲	PTL-31-483	White	38.10	25.40	-	28.57	250	M61-R6010	BMP61, BMP71, M611
▲	PTL-32-483	White	38.10	38.10	-	41.27	250	M61-R6010	BMP61, BMP71, M611
▲	PTL-30-483	White	38.10	19.05	-	22.22	250	M61-R6010	BMP61, BMP71, M611
▲	PTL-37-483	White	48.26	76.20	-	79.37	100	M61-R6010	BMP61, BMP71, M611
▲	PTL-38-483	White	48.26	101.60	-	104.77	100	M61-R6010	BMP61, BMP71, M611
▲	PTL-20-483	White	50.80	25.40	-	28.57	100	M61-R6010	BMP61, BMP71, M611
∞	PTL-8-483	White	12.70	-	15.24	-	1	M61-R6010	BMP61, BMP71, M611
∞	PTL-100-483	White	33.02	-	15.24	-	1	M61-R6010	BMP61, BMP71, M611
<b>B-486B: Metallised Polyester</b>									
▲	PTL-16-486	Silver	25.40	9.53	-	12.70	500	M61-R4310	BMP61, BMP71, M611
▲	PTL-17-486	Silver	25.40	12.70	-	15.87	500	M61-R4310	BMP61, BMP71, M611
▲	PTL-19-486	Silver	25.40	25.40	-	28.57	250	M61-R4310	BMP61, BMP71, M611
◐	PTL-24-486-BK	Silver with 1.6 mm Black Border	28.70	12.70	-	15.87	500	M61-R4310	BMP61, BMP71, M611
▲	PTL-30-486	Silver	38.10	19.05	-	22.22	250	M61-R4310	BMP61, BMP71, M611
▲	PTL-29-486	Silver	38.10	12.70	-	15.88	500	M61-R4310	BMP61, BMP71, M611
▲	PTL-31-486	Silver	38.10	25.40	-	28.57	250	M61-R4310	BMP61, BMP71, M611
▲	PTL-32-486	Silver	38.10	38.10	-	41.27	250	M61-R4310	BMP61, BMP71, M611
▲	PTL-37-486	Silver	48.26	76.20	-	79.37	100	M61-R4310	BMP61, BMP71, M611
▲	PTL-38-486	Silver	48.26	101.60	-	104.77	100	M61-R4310	BMP61, BMP71, M611
▲	PTL-20-486	Silver	50.80	25.40	-	28.57	100	M61-R4310	BMP61, BMP71, M611
∞	PTL-43-486	Silver	48.26	-	15.24	-	1	M61-R4310	BMP61, BMP71, M611
<b>B-489A: Polyester</b>									
▲	PTL-16-489	White	25.40	9.53	-	12.70	500	M61-R4310	BMP61, BMP71, M611
▲	PTL-17-489	White	25.40	12.70	-	15.87	500	M61-R4310	BMP61, BMP71, M611
▲	PTL-19-489	White	25.40	25.40	-	28.57	250	M61-R4310	BMP61, BMP71, M611
▲	PTL-30-489	White	38.10	19.05	-	22.22	250	M61-R4310	BMP61, BMP71, M611
▲	PTL-29-489	White	38.10	12.70	-	15.88	500	M61-R4310	BMP61, BMP71, M611
▲	PTL-31-489	White	38.10	25.40	-	28.57	250	M61-R4310	BMP61, BMP71, M611
▲	PTL-32-489	White	38.10	38.10	-	41.27	250	M61-R4310	BMP61, BMP71, M611
▲	PTL-37-489	White	48.26	76.20	-	79.37	100	M61-R4310	BMP61, BMP71, M611
▲	PTL-38-489	White	48.26	101.60	-	104.77	100	M61-R4310	BMP61, BMP71, M611
▲	PTL-20-489	White	50.80	25.40	-	28.57	100	M61-R4310	BMP61, BMP71, M611
∞	PTL-101-489	White	6.35	-	15.24	-	1	M61-R4310	BMP61, BMP71, M611
∞	PTL-8-489	White	12.70	-	15.24	-	1	M61-R4310	BMP61, BMP71, M611
∞	PTL-42-489	White	25.40	-	15.24	-	1	M61-R4310	BMP61, BMP71, M611
∞	PTL-100-489	White	33.02	-	15.24	-	1	M61-R4310	BMP61, BMP71, M611
∞	PTL-43-489	White	48.26	-	15.24	-	1	M61-R4310	BMP61, BMP71, M611
<b>B-499: Nylon Cloth</b>									
▲	PTL-81-499	White	48.26	6.35	-	9.53	750	M61-R4310	BMP61, BMP71, M611
▲	PTL-78-499	White	48.26	25.40	-	28.57	250	M61-R4310	BMP61, BMP71, M611



See pages 49-53 for a detailed material index.

## Asset & component marking



### PermaShield Labels

- These labels come with a separate overlaminate to be applied over the printed label.
- The label remains clear and easy-to-read, even in very harsh environments.
- The overlaminate extends outside of the label on each side when applied.

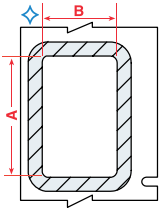
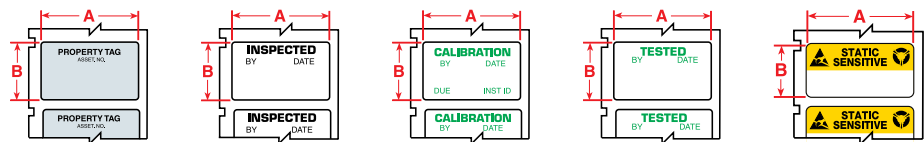

Diagram	Order Reference	Colour	Label Width A (mm)	Label Height B (mm)	Overlaminat Dimensions - Width (mm)	Overlaminat Dimensions - Height (mm)	Vertical Repeat D (mm)	Labels per Roll	Printer Ribbon Series	Printer Compatibility
<b>B-422/B-966B: Polyester</b>										
◆	PTPSL-17-422	White	25.40	12.70	31.75	19.05	28.57	500	M61-R6010	BMP61, BMP71, M611
◆	PTPSL-20-422	White	50.80	25.40	57.15	31.75	53.97	100	M61-R6010	BMP61, BMP71, M611
◆	PTPSL-26-422	White	69.85	31.75	76.20	38.10	73.02	100	M61-R6010	BMP61, BMP71, M611
◆	PTPSL-50-422	White	76.20	41.91	82.55	48.26	79.37	100	M61-R6010	BMP61, BMP71, M611
<b>B-424/B-966B: Paper with Polyester Overlaminat</b>										
◆	PTPSL-17-424	White	25.40	12.70	31.75	19.05	28.57	500	M61-R4310	BMP61, BMP71, M611
◆	PTPSL-20-424	White	50.80	25.40	57.15	31.75	53.97	100	M61-R4310	BMP61, BMP71, M611
<b>B-428/B-966: Metallised Polyester with Polyester Overlaminat</b>										
◆	PTPSL-17-428	Silver	25.40	12.70	31.75	19.05	28.57	500	M61-R4310	BMP61, BMP71, M611
◆	PTPSL-20-428	Silver	50.80	25.40	57.15	31.75	53.97	100	M61-R4310	BMP61, BMP71, M611
◆	PTPSL-26-428	Silver	69.85	31.75	76.20	38.10	73.02	100	M61-R4310	BMP61, BMP71, M611
◆	PTPSL-50-428	Silver	76.20	41.91	82.55	48.26	79.37	100	M61-R4310	BMP61, BMP71, M611



### Pre-printed labels

- Printable labels with pre-printed headers allow customers to print variable information next to highly visible titles.



Order Reference	Colour	Label Width A (mm)	Label Height B (mm)	Vertical Repeat D (mm)	Legend	Labels per Roll	Printer Ribbon Series	Printer Compatibility
<b>B-422: Polyester</b>								
PTL-35-422-PROP	Black on White	41.40	19.05	22.22	PROPERTY TAG	250	M61-R6010	BMP61, BMP71, M611
<b>B-423: Polyester</b>								
PTL-30-423-INSP	Black on White	19.05	38.10	41.27	INSPECTED BY	250	M61-R6010	BMP61, BMP71, M611
PTL-30-423-CALI	Green on White	19.05	38.10	41.27	CALIBRATION	250	M61-R6010	BMP61, BMP71, M611
PTL-30-423-TEST	Green on White	19.05	38.10	41.27	TESTED	250	M61-R6010	BMP61, BMP71, M611
PTL-35-423-PROP	Black on White	41.40	19.05	22.22	PROPERTY TAG	250	M61-R6010	BMP61, BMP71, M611
<b>B-428: Metallised Polyester</b>								
PTL-30-428-CALI	Green on Silver	19.05	38.10	41.27	CALIBRATION	250	M61-R4310	BMP61, BMP71, M611
PTL-35-428-PROP	Black on Silver	41.40	19.05	22.22	PROPERTY TAG	250	M61-R4310	BMP61, BMP71, M611
<b>B-473: Static Dissipative Polyester</b>								
PTLSL-17-473	Black on Yellow & White	25.40	12.70	15.87	STATIC SENSITIVE (EIA Std. 471 & MIL Std. 129J symbols)	500	M61-R6010	BMP61, BMP71, M611



See pages 49-53 for a detailed material index.

## Asset & component marking

### General industrial identification

- Pliable vinyl that conforms well to smooth or rough surfaces such as walls, doors, panels, shelving and equipment. Excellent resistance to oils, detergents, dirt, grime and many solvents.



Diagram	Order Reference	Colour	Label Width A (mm)	Label Length B (m)	Labels per Roll	Printer Ribbon Series	Printer Compatibility
<b>B-439: Vinyl</b>							
∞	PTL-8-439-BK	Black	12.70	15.24	1	M61-R4410-WT	BMP61, BMP71, M611
∞	PTL-8-439-BL	Blue	12.70	15.24	1	M61-R6010	BMP61, BMP71, M611
∞	PTL-8-439-GN	Green	12.70	15.24	1	M61-R6010	BMP61, BMP71, M611
∞	PTL-8-439-OR	Orange	12.70	15.24	1	M61-R6010	BMP61, BMP71, M611
∞	PTL-8-439-RD	Red	12.70	15.24	1	M61-R6010	BMP61, BMP71, M611
∞	PTL-8-439	White	12.70	15.24	1	M61-R6010	BMP61, BMP71, M611
∞	PTL-8-439-YL	Yellow	12.70	15.24	1	M61-R6010	BMP61, BMP71, M611
∞	PTL-42-439-BK	Black	25.40	15.24	1	M61-R4410-WT	BMP61, BMP71, M611
∞	PTL-42-439-BL	Blue	25.40	15.24	1	M61-R6010	BMP61, BMP71, M611
∞	PTL-42-439-GR	Green	25.40	15.24	1	M61-R6010	BMP61, BMP71, M611
∞	PTL-42-439-OR	Orange	25.40	15.24	1	M61-R6010	BMP61, BMP71, M611
∞	PTL-42-439-RD	Red	25.40	15.24	1	M61-R6010	BMP61, BMP71, M611
∞	PTL-42-439	White	25.40	15.24	1	M61-R6010	BMP61, BMP71, M611
∞	PTL-42-439-YL	Yellow	25.40	15.24	1	M61-R6010	BMP61, BMP71, M611
∞	PTL-43-439-BK	Black	48.26	15.24	1	M61-R4410-WT	BMP61, BMP71, M611
∞	PTL-43-439-BL	Blue	48.26	15.24	1	M61-R6010	BMP61, BMP71, M611
∞	PTL-43-439-GR	Green	48.26	15.24	1	M61-R6010	BMP61, BMP71, M611
∞	PTL-43-439-OR	Orange	48.26	15.24	1	M61-R6010	BMP61, BMP71, M611
∞	PTL-43-439-RD	Red	48.26	15.24	1	M61-R6010	BMP61, BMP71, M611
∞	PTL-43-439	White	48.26	15.24	1	M61-R6010	BMP61, BMP71, M611
∞	PTL-43-439-YL	Yellow	48.26	15.24	1	M61-R6010	BMP61, BMP71, M611

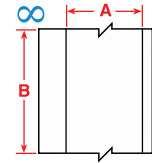

## Component marking

### Security identification labels

- Tamper-resistant tape destructs into tiny fragments when being removed, makes any attempts to remove the label very difficult and time consuming.

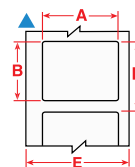
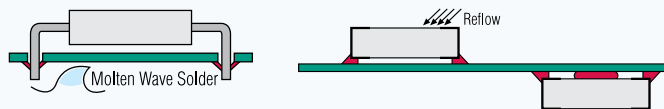

Diagram	Order Reference	Colour	Label Width A (mm)	Label Height B (mm)	Vertical Repeat D (mm)	Labels per Roll	Printer Ribbon Series	Printer Compatibility
<b>B-362: Tamper-resistant Metallised Vinyl</b>								
▲	PTL-17-362	Silver	25.40	12.70	15.87	500	M61-R6010	BMP61, BMP71, M611
▲	PTL-31-362	Silver	38.10	25.40	28.57	250	M61-R6010	BMP61, BMP71, M611
▲	PTL-37-362	Silver	48.26	76.20	79.37	100	M61-R6010	BMP61, BMP71, M611
▲	PTL-20-362	Silver	50.80	25.40	28.57	100	M61-R6010	BMP61, BMP71, M611
<b>B-7351: Tamper-resistant Vinyl</b>								
▲	PTL-17-7351	White	25.40	12.70	15.87	500	M61-R6010	BMP61, BMP71, M611
▲	PTL-31-7351	White	38.10	25.40	28.57	250	M61-R6010	BMP61, BMP71, M611
▲	PTL-37-351	White	48.26	76.20	79.37	100	M61-R6010	BMP61, BMP71, M611
▲	PTL-20-7351	White	50.80	25.40	28.57	100	M61-R6010	BMP61, BMP71, M611
<b>B-7546: Tamper-evident Polyester</b>								
▲	PTL-17-7546	White	25.40	12.70	15.87	500	M61-R6010	BMP61, BMP71, M611
▲	PTL-31-7546	White	38.10	25.40	28.57	250	M61-R6010	BMP61, BMP71, M611
▲	PTL-20-7546	White	50.80	25.40	28.57	100	M61-R6010	BMP61, BMP71, M611
<b>B-7576: Tamper-evident Metallised Polyester</b>								
▲	PTL-17-7576	Silver	25.40	12.70	15.87	500	M61-R6010	BMP61, BMP71, M611
▲	PTL-31-7576	Silver	38.10	25.40	28.57	250	M61-R6010	BMP61, BMP71, M611
▲	PTL-37-7576	Silver	48.26	76.20	79.37	100	M61-R6010	BMP61, BMP71, M611
▲	PTL-20-7576	Silver	50.80	25.40	28.57	100	M61-R6010	BMP61, BMP71, M611



## Thermal transfer printable products circuit board process chart



	Through Hole Technology		Surface Mount Technology (SMT)	
	Top	Bottom	Top or Bottom	After Process
B-717, B-718, B-719, B-724, B-727	Yes	Yes	Yes	Yes
B-422, B-423, B-430, B-437, B-459, B-473, B-488	Yes*	No	No	Yes

\*In extreme high temperature, testing of these materials is recommended

## Circuit board marking



### Polyester labels

- Various types of high resistant polyester materials for relays, solenoids, PCB's, electronic components and more.

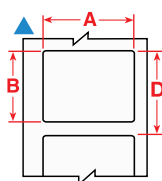

Diagram	Order Reference	Colour	Label Width A (mm)	Label Height B (mm)	Label Length B (m)	Vertical Repeat D (mm)	Labels per Roll	Printer Ribbon Series	Printer Compatibility
<b>B-422: Polyester</b>									
⊗	PTL-39-422	White	9.53	15.24	-	-	750	M61-R6010	BMP61, BMP71, M611
▲	PTL-5-422	White	12.70	5.08	-	8.25	750	M61-R6010	BMP61, BMP71, M611
▲	PTL-44-422	White	12.70	9.53	-	12.70	500	M61-R6010	BMP61, BMP71, M611
▲	PTL-7-422	White	12.70	12.70	-	15.87	500	M61-R6010	BMP61, BMP71, M611
▲	PTL-19-422	White	25.40	25.40	-	28.57	250	M61-R6010	BMP61, BMP71, M611
▲	PTL-22-422	White	25.40	76.20	-	79.37	100	M61-R6010	BMP61, BMP71, M611
▲	PTL-23-422	White	25.40	101.60	-	104.77	100	M61-R6010	BMP61, BMP71, M611
▲	PTL-17-422	White	25.40	12.70	-	15.87	500	M61-R6010	BMP61, BMP71, M611
▲	PTL-16-422	White	25.40	9.53	-	12.70	500	M61-R6010	BMP61, BMP71, M611
▲	PTL-29-422	White	38.10	12.70	-	15.88	500	M61-R6010	BMP61, BMP71, M611
▲	PTL-30-422	White	38.10	19.05	-	22.22	250	M61-R6010	BMP61, BMP71, M611
▲	PTL-32-422	White	38.10	38.10	-	41.28	250	M61-R6010	BMP61, BMP71, M611
▲	PTL-45-422	White	38.10	9.53	-	12.70	500	M61-R6010	BMP61, BMP71, M611
▲	PTL-37-422	White	48.26	76.20	-	79.37	100	M61-R6010	BMP61, BMP71, M611
▲	PTL-38-422	White	48.26	101.60	-	104.77	100	M61-R6010	BMP61, BMP71, M611
▲	PTL-20-422	White	50.80	25.40	-	28.57	100	M61-R6010	BMP61, BMP71, M611
<b>B-423: Polyester</b>									
▲	PTL-1-423	White	6.35	6.35	-	9.53	750	M61-R6010	BMP61, BMP71, M611
▲	PTL-3-423	White	9.53	9.53	-	12.70	500	M61-R6010	BMP61, BMP71, M611
▲	PTL-4-423	White	10.16	10.16	-	13.33	500	M61-R6010	BMP61, BMP71, M611
▲	PTL-5-423	White	12.70	5.08	-	8.25	750	M61-R6010	BMP61, BMP71, M611
▲	PTL-6-423	White	12.70	6.99	-	10.16	750	M61-R6010	BMP61, BMP71, M611
▲	PTL-7-423	White	12.70	12.70	-	15.87	500	M61-R6010	BMP61, BMP71, M611
▲	BM71-7-423	White	12.70	12.70	-	15.88	5000	M61-R6010	BMP61, BMP71, M611
▲	PTL-9-423	White	16.51	5.08	-	8.25	750	M61-R6010	BMP61, BMP71, M611
▲	PTL-13-423	White	22.86	6.35	-	9.53	750	M61-R6010	BMP61, BMP71, M611
▲	PTL-14-423	White	25.40	4.75	-	7.92	750	M61-R6010	BMP61, BMP71, M611
▲	PTL-15-423	White	25.40	6.99	-	10.16	750	M61-R6010	BMP61, BMP71, M611
▲	PTL-16-423	White	25.40	9.53	-	12.70	500	M61-R6010	BMP61, BMP71, M611
▲	PTL-17-423	White	25.40	12.70	-	15.87	500	M61-R6010	BMP61, BMP71, M611
▲	PTL-19-423	White	25.40	25.40	-	28.57	250	M61-R6010	BMP61, BMP71, M611
▲	PTL-22-423	White	25.40	76.20	-	79.37	100	M61-R6010	BMP61, BMP71, M611
▲	PTL-23-423	White	25.40	101.60	-	104.77	100	M61-R6010	BMP61, BMP71, M611
▲	BM71-17-423	White	25.40	12.70	-	15.88	5000	M61-R6010	BMP61, BMP71, M611
▲	BM71-20-423	White	25.40	50.80	-	53.98	1000	M61-R6010	BMP61, BMP71, M611

>>



See pages 49-53 for a detailed material index.

Polyester labels (continued)

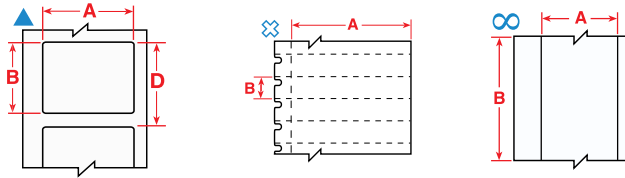

Diagram	Order Reference	Colour	Label Width A (mm)	Label Height B (mm)	Label Length B (m)	Vertical Repeat D (mm)	Labels per Roll	Printer Ribbon Series	Printer Compatibility
▲	BM71-16-423	White	25.40	9.53	-	12.70	5000	M61-R6010	BMP61, BMP71, M611
▲	PTL-25-423	White	31.75	6.35	-	9.53	750	M61-R6010	BMP61, BMP71, M611
▲	PTL-26-423	White	31.75	69.85	-	73.02	100	M61-R6010	BMP61, BMP71, M611
▲	PTL-27-423	White	38.10	3.18	-	6.35	750	M61-R6010	BMP61, BMP71, M611
▲	PTL-28-423	White	38.10	6.35	-	9.53	750	M61-R6010	BMP61, BMP71, M611
▲	PTL-29-423	White	38.10	12.70	-	15.88	500	M61-R6010	BMP61, BMP71, M611
▲	PTL-31-423	White	38.10	25.40	-	28.57	250	M61-R6010	BMP61, BMP71, M611
▲	PTL-32-423	White	38.10	38.10	-	41.27	250	M61-R6010	BMP61, BMP71, M611
▲	BM71-29-423	White	38.10	12.70	-	15.88	5000	M61-R6010	BMP61, BMP71, M611
▲	PTL-37-423	White	48.26	76.20	-	79.37	100	M61-R6010	BMP61, BMP71, M611
▲	PTL-38-423	White	48.26	101.60	-	104.77	100	M61-R6010	BMP61, BMP71, M611
▲	PTL-2-423	White	50.80	6.35	-	9.53	100	M61-R6010	BMP61, BMP71, M611
▲	PTL-20-423	White	50.80	25.40	-	28.57	100	M61-R6010	BMP61, BMP71, M611
∞	PTL-8-423	White	12.70	-	15.24	-	1	M61-R6010	BMP61, BMP71, M611
<b>B-430: Polyester</b>									
▲	PTL-71-430	Clear	8.89	5.08	-	8.25	750	M61-R6010	BMP61, BMP71, M611
▲	PTL-7-430	Clear	12.70	12.70	-	15.87	500	M61-R6010	BMP61, BMP71, M611
▲	PTL-6-430	Clear	12.70	6.99	-	10.16	750	M61-R6010	BMP61, BMP71, M611
▲	PTL-44-430	Clear	12.70	9.53	-	12.70	500	M61-R6010	BMP61, BMP71, M611
<b>B-437: Polyvinylfluoride</b>									
▲	PTL-10-437	White	19.05	6.35	-	9.53	750	M61-R4310	BMP61, BMP71, M611
▲	PTL-15-437	White	25.40	6.99	-	10.16	750	M61-R4310	BMP61, BMP71, M611
▲	PTL-29-437	White	38.10	12.70	-	15.87	500	M61-R4310	BMP61, BMP71, M611
<b>B-459: Polyester</b>									
▲	PTL-29-459	White	38.10	12.70	-	15.88	500	M61-R6010	BMP61, BMP71, M611
▲	PTL-30-459	White	38.10	19.05	-	22.22	250	M61-R6010	BMP61, BMP71, M611
▲	PTL-20-459	White	50.80	25.40	-	28.57	100	M61-R6010	BMP61, BMP71, M611
<b>B-473: Static Dissipative Polyester</b>									
▲	PTL-1-473	White	6.35	6.35	-	9.53	750	M61-R6010	BMP61, BMP71, M611
▲	PTL-5-473	White	12.70	5.08	-	8.25	750	M61-R6010	BMP61, BMP71, M611
▲	PTL-6-473	White	12.70	6.99	-	10.16	750	M61-R6010	BMP61, BMP71, M611
▲	PTL-9-473	White	16.51	5.08	-	8.25	750	M61-R6010	BMP61, BMP71, M611
▲	PTL-10-473	White	19.05	6.35	-	9.53	750	M61-R6010	BMP61, BMP71, M611
▲	PTL-16-473	White	25.40	9.53	-	12.70	500	M61-R6010	BMP61, BMP71, M611
▲	PTL-17-473	White	25.40	12.70	-	15.87	500	M61-R6010	BMP61, BMP71, M611
▲	PTL-28-473	White	38.10	6.35	-	9.53	750	M61-R6010	BMP61, BMP71, M611
<b>B-488: Polyester</b>									
▲	PTL-80-488	White	19.05	22.86	-	26.03	250	M61-R4310	BMP61, BMP71, M611
▲	PTL-97-488	White	22.86	22.86	-	26.03	250	M61-R4310	BMP61, BMP71, M611
▲	PTL-81-488	White	48.26	6.35	-	9.53	750	M61-R4310	BMP61, BMP71, M611
▲	PTL-78-488	White	48.26	25.40	-	28.58	250	M61-R4310	BMP61, BMP71, M611

## Circuit board marking



### Polyimide labels

- Various types of high resistant polyimide materials for relays, solenoids, PCB's and electronic components.

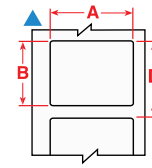

Diagram	Order Reference	Colour	Label Width A (mm)	Label Height B (mm)	Vertical Repeat D (mm)	Labels per Roll	Printer Ribbon Series	Printer Compatibility
<b>B-717: Polyimide</b>								
▲	PTL-1-717	White	6.35	6.35	9.53	750	M61-R6010	BMP61, BMP71, M611
▲	PTL-3-717	White	9.53	9.53	12.70	500	M61-R6010	BMP61, BMP71, M611
▲	PTL-9-717	White	16.51	5.08	8.25	750	M61-R6010	BMP61, BMP71, M611
▲	PTL-10-717	White	19.05	6.35	9.53	750	M61-R6010	BMP61, BMP71, M611
▲	PTL-14-717	White	25.40	4.75	7.92	750	M61-R6010	BMP61, BMP71, M611
▲	PTL-25-717	White	31.75	6.35	9.53	750	M61-R6010	BMP61, BMP71, M611
▲	PTL-27-717	White	38.10	3.18	6.35	750	M61-R6010	BMP61, BMP71, M611
▲	PTL-28-717	White	38.10	6.35	9.53	750	M61-R6010	BMP61, BMP71, M611
▲	PTL-2-717	White	50.80	6.35	9.53	100	M61-R6010	BMP61, BMP71, M611
<b>B-718: Polyimide</b>								
▲	PTL-1-718	White	6.35	6.35	9.53	750	M61-R6010	BMP61, BMP71, M611
▲	PTL-3-718	White	9.53	9.53	12.70	500	M61-R6010	BMP61, BMP71, M611
▲	PTL-4-718	White	10.16	10.16	13.33	500	M61-R6010	BMP61, BMP71, M611
▲	PTL-6-718	White	12.70	6.99	10.16	750	M61-R6010	BMP61, BMP71, M611
▲	PTL-9-718	White	16.51	5.08	8.25	750	M61-R6010	BMP61, BMP71, M611
▲	PTL-10-718	White	19.05	6.35	9.53	750	M61-R6010	BMP61, BMP71, M611
▲	PTL-13-718	White	22.86	6.35	9.53	750	M61-R6010	BMP61, BMP71, M611
▲	PTL-14-718	White	25.40	4.75	7.92	750	M61-R6010	BMP61, BMP71, M611
▲	PTL-16-718	White	25.40	9.53	12.70	500	M61-R6010	BMP61, BMP71, M611
▲	PTL-28-718	White	38.10	6.35	9.53	750	M61-R6010	BMP61, BMP71, M611
<b>B-719: Polyimide</b>								
▲	PTL-4-719	White	10.16	10.16	13.33	500	M61-R6010	BMP61, BMP71, M611
▲	PTL-6-719	White	12.70	6.99	10.16	750	M61-R6010	BMP61, BMP71, M611
▲	PTL-9-719	White	16.51	5.08	8.25	750	M61-R6010	BMP61, BMP71, M611
▲	PTL-10-719	White	19.05	6.35	9.53	750	M61-R6010	BMP61, BMP71, M611
▲	PTL-13-719	White	22.86	6.35	9.53	750	M61-R6010	BMP61, BMP71, M611
▲	PTL-16-719	White	25.40	9.53	12.70	500	M61-R6010	BMP61, BMP71, M611
▲	PTL-17-719	White	25.40	12.70	15.87	500	M61-R6010	BMP61, BMP71, M611
▲	PTL-28-719	White	38.10	6.35	9.53	750	M61-R6010	BMP61, BMP71, M611
<b>B-724: Polyimide</b>								
▲	PTL-1-724	Amber	6.35	6.35	9.53	750	M61-R4310	BMP61, BMP71, M611
▲	PTL-3-724	Amber	9.53	9.53	12.70	500	M61-R4310	BMP61, BMP71, M611
▲	PTL-4-724	Amber	10.16	10.16	13.33	500	M61-R4310	BMP61, BMP71, M611
▲	PTL-6-724	Amber	12.70	6.99	10.16	750	M61-R4310	BMP61, BMP71, M611
▲	PTL-9-724	Amber	16.51	5.08	8.25	750	M61-R4310	BMP61, BMP71, M611
▲	PTL-10-724	Amber	19.05	6.35	9.53	750	M61-R4310	BMP61, BMP71, M611
▲	PTL-13-724	Amber	22.86	6.35	9.53	750	M61-R4310	BMP61, BMP71, M611
▲	PTL-16-724	Amber	25.40	9.53	12.70	500	M61-R4310	BMP61, BMP71, M611
▲	PTL-17-724	Amber	25.40	12.70	15.87	500	M61-R4310	BMP61, BMP71, M611
▲	PTL-25-724	Amber	31.75	6.35	9.53	750	M61-R4310	BMP61, BMP71, M611
▲	PTL-27-724	Amber	38.10	3.18	6.35	750	M61-R4310	BMP61, BMP71, M611
▲	PTL-28-724	Amber	38.10	6.35	9.53	750	M61-R4310	BMP61, BMP71, M611
▲	PTL-2-724	Amber	50.80	6.35	9.53	100	M61-R4310	BMP61, BMP71, M611
<b>B-727: Polyimide</b>								
▲	PTL-1-727	White	6.35	6.35	9.53	750	M61-R6010	BMP61, BMP71, M611
▲	PTL-3-727	White	9.53	9.53	12.70	500	M61-R6010	BMP61, BMP71, M611
▲	PTL-4-727	White	10.16	10.16	13.33	500	M61-R6010	BMP61, BMP71, M611
▲	PTL-6-727	White	12.70	6.99	10.16	750	M61-R6010	BMP61, BMP71, M611
▲	PTL-9-727	White	16.51	5.08	8.25	750	M61-R6010	BMP61, BMP71, M611
▲	PTL-10-727	White	19.05	6.35	9.53	750	M61-R6010	BMP61, BMP71, M611
▲	PTL-13-727	White	22.86	6.35	9.53	750	M61-R6010	BMP61, BMP71, M611
▲	PTL-14-727	White	25.40	4.75	7.92	750	M61-R6010	BMP61, BMP71, M611
▲	PTL-16-727	White	25.40	9.53	12.70	500	M61-R6010	BMP61, BMP71, M611
▲	PTL-28-727	White	38.10	6.35	9.53	750	M61-R6010	BMP61, BMP71, M611
▲	PTL-2-727	White	50.80	6.35	9.53	100	M61-R6010	BMP61, BMP71, M611

## Specimen tracking identification

- F** Freezer environment
- N** Liquid nitrogen environment
- A** Autoclave environment
- H** Hot water bath (100°C)
- S** Self-laminating label
- L** Low-profile (extremely thin) label
- R** Removable

### Straw and rod labels

- Brady offers a range of labels designed to fit the small surface area of straws and rods and will withstand long-term storage.

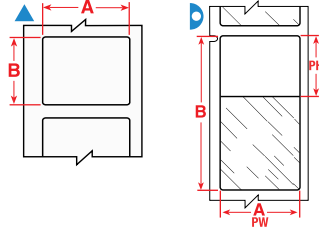

Labels are shown per straw size and in order of label width.

The background colours in the Order Reference column represent the material colour.

Diagram	Material	Special Properties	Label Width A (mm)	Label Height B (mm)	Label Length B (m)	Printable Area Width PW (mm)	Printable Area Height PH (mm)	Order Reference	Printer Compatibility	Printer Ribbon Series	Labels per Roll
<b>0.25 ml</b>											
▷	B-427	F N S	25.40	25.40	-	25.40	9.53	PTL-19-427	BMP61, BMP71, M611	M61-R4310	250
▷	B-427	F N S	25.40	25.40	-	25.40	9.53	PTL-19-427-YL	BMP61, BMP71, M611	M61-R4310	250
▷	B-427	F N S	25.40	25.40	-	25.40	9.53	PTL-19-427-OR	BMP61, BMP71, M611	M61-R4310	250
▷	B-427	F N S	25.40	25.40	-	25.40	9.53	PTL-19-427-GR	BMP61, BMP71, M611	M61-R4310	250
▷	B-427	F N S	25.40	25.40	-	25.40	9.53	PTL-19-427-GY	BMP61, BMP71, M611	M61-R4310	250
▷	B-427	F N S	25.40	25.40	-	25.40	9.53	PTL-19-427-PL	BMP61, BMP71, M611	M61-R4310	250
▷	B-427	F N S	25.40	25.40	-	25.40	9.53	PTL-19-427-BL	BMP61, BMP71, M611	M61-R4310	250
▷	B-427	F N S	25.40	25.40	-	25.40	9.53	PTL-19-427-BR	BMP61, BMP71, M611	M61-R4310	250
▷	B-427	F N S	25.40	25.40	-	25.40	9.53	PTL-19-427-RD	BMP61, BMP71, M611	M61-R4310	250
▷	B-427	F N S	25.40	25.40	-	25.40	9.53	BM71-19-427	BMP61, BMP71, M611	M61-R4300	2500
▲	B-427	F N	27.94	6.35	-	27.94	6.35	PTL-105-427-AW*	BMP61, BMP71, M611	M61-R4310	750
<b>0.50 ml</b>											
▷	B-427	F N S	25.40	63.50	-	25.40	19.05	PTL-21-427	BMP61, BMP71, M611	M61-R4310	100
▷	B-427	F N S	25.40	63.50	-	25.40	19.05	PTL-21-427-YL	BMP61, BMP71, M611	M61-R4310	100
▷	B-427	F N S	25.40	63.50	-	25.40	19.05	PTL-21-427-OR	BMP61, BMP71, M611	M61-R4310	100
▷	B-427	F N S	25.40	63.50	-	25.40	19.05	PTL-21-427-GR	BMP61, BMP71, M611	M61-R4310	100
▷	B-427	F N S	25.40	63.50	-	25.40	19.05	PTL-21-427-GY	BMP61, BMP71, M611	M61-R4310	100
▷	B-427	F N S	25.40	63.50	-	25.40	19.05	PTL-21-427-PL	BMP61, BMP71, M611	M61-R4310	100
▷	B-427	F N S	25.40	63.50	-	25.40	19.05	PTL-21-427-BL	BMP61, BMP71, M611	M61-R4310	100
▷	B-427	F N S	25.40	63.50	-	25.40	19.05	PTL-21-427-BR	BMP61, BMP71, M611	M61-R4310	100
▷	B-427	F N S	25.40	63.50	-	25.40	19.05	PTL-21-427-RD	BMP61, BMP71, M611	M61-R4310	100
▷	B-427	F N S	25.40	63.50	-	25.40	19.05	BM71-21-427	BMP61, BMP71, M611	M61-R4300	1000

\*AW = All White / no transparent area.



See pages 49-53 for a detailed material index.

## Specimen tracking identification



### Vial / tube labels

- Brady's vial and test tube labels are designed to withstand extreme laboratory solvents like Xylene, Ethanol, Alcohol and DMSO, ensuring that the specimen identification is always legible - and will not smear, fade or fall off.

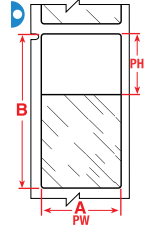
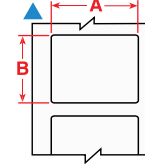
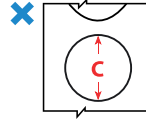
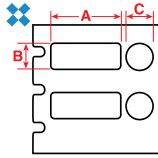

The background colours in the Order Reference column represent the material colour.

Labels are shown per vial / tube size and in order of label width.

Diagram	Material	Special Properties	Label Width A (mm)	Label Height B (mm)	Label Length B (m)	Diameter C (mm)	Printable Area Width PW (mm)	Printable Area Height PH (mm)	Order Reference	Printer Compatibility	Printer Ribbon Series	Labels per Roll
0.5 - 0.7 ml												
▲	B-498	F R	19.05	12.70	-	-	-	-	BM71-11-498	BMP61, BMP71, M611	M61-R6210	5000
0.5 ml												
▷	B-427	F N S	25.40	63.50	-	-	25.40	19.05	PTL-21-427	BMP61, BMP71, M611	M61-R4310	100
0.6 - 1.5 ml												
✕	B-499	F N A	-	-	-	9.53	-	-	PTL-82-499-YL	BMP61, BMP71, M611	M61-R4310	500
✕	B-499	F N A	-	-	-	9.53	-	-	PTL-82-499	BMP61, BMP71, M611	M61-R4310	500
✕	B-499	F N A	25.40	9.53	-	9.53	-	-	PTL-98-499	BMP61, BMP71, M611	M61-R4310	500
✕	B-7425	F N A H	25.40	9.53	-	9.53	25.40	9.53	M61-98-7425	M611; BMP61	M61-R6400	500
1.0 - 2.0 ml												
✕	B-499	F N A	-	-	-	12.70	-	-	PTL-83-499-YL	BMP61, BMP71, M611	M61-R4310	500
✕	B-499	F N A	-	-	-	12.70	-	-	PTL-83-499	BMP61, BMP71, M611	M61-R4310	500
1.0 - 8.0 ml												
▲	B-499	F N A	22.86	12.70	-	-	-	-	PTL-84-499	BMP61, BMP71, M611	M61-R4310	500
▲	B-498	F R	25.40	19.05	-	-	-	-	BM71-18-498	BMP61, BMP71, M611	M61-R6210	2500
▷	B-461	F N A H S L	25.40	66.68	-	-	25.40	25.40	PTL-75-461	BMP61, BMP71, M611	M61-R4310	100
▷	B-427	F N S	25.40	66.68	-	-	25.40	25.40	PTL-75-427	BMP61, BMP71, M611	M61-R4310	100
▷	B-461	F N A H S L	25.40	66.68	-	-	25.40	25.40	PTL-75-461-YL	BMP61, BMP71, M611	M61-R4310	100
▷	B-461	F N A H S L	25.40	66.68	-	-	25.40	25.40	BM71-75-461	BMP61, BMP71, M611	M61-R6210	1000
▲	B-490	F N H L	48.26	25.40	-	-	-	-	PTL-78-490	BMP61, BMP71, M611	M61-R4310	250
12.0 - 24.0 ml												
▷	B-461	F N A H S L	19.05	95.25	-	-	19.05	25.40	PTL-79-461	BMP61, BMP71, M611	M61-R4310	100
▲	B-498	F R	38.10	12.70	-	-	-	-	BM71-29-498	BMP61, BMP71, M611	M61-R6210	5000
15.0 ml												
▲	B-7425	F N A H	38.10	25.40	-	-	38.10	25.40	M61-31-7425	M611; BMP61	M61-R6400	250
▲	B-7425	F N A H	48.25	38.10	-	-	48.30	38.10	M61-121-7425	M611; BMP61	M61-R6400	100

- F** Freezer environment
- N** Liquid nitrogen environment
- A** Autoclave environment
- H** Hot water bath (100°C)
- S** Self-laminating label
- L** Low-profile (extremely thin) label
- R** Removable

## Specimen tracking identification

### Conical / large tube labels

- Brady offers several sample identification labels which are perfect to identify conicals. They are easy to handle, have great flexibility and easily wrap around curved sample containers. Your sample identification label will remain attached and legible, even when the sample is stored in a freezer, in liquid nitrogen or heated in an autoclave.

- F** Freezer environment
- N** Liquid nitrogen environment
- A** Autoclave environment
- H** Hot water bath (100°C)
- S** Self-laminating label
- L** Low-profile (extremely thin) label
- R** Removable

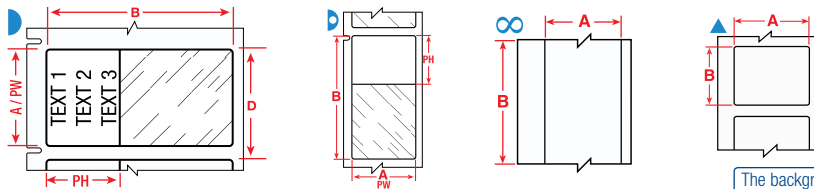

Labels are shown per vial / tube size and in order of label width.

The background colours in the Order Reference column represent the material colour.

Diagram	Material	Special Properties	Label Width A (mm)	Label Height B (mm)	Label Length B (m)	Printable Area Width PW (mm)	Printable Area Height PH (mm)	Order Reference	Printer Compatibility	Printer Ribbon Series	Labels per Roll
<b>0.5 ml</b>											
▶	B-427	F N S	25.40	63.50	-	25.40	19.05	PTL-21-427	BMP61, BMP71, M611	M61-R4310	100
<b>1.0 - 8.0 ml</b>											
▲	B-499	F N A	22.86	12.70	-	-	-	PTL-84-499	BMP61, BMP71, M611	M61-R4310	500
▶	B-461	F N A H S L	25.40	66.68	-	25.40	25.40	BM71-75-461	BMP61, BMP71, M611	M61-R6210	1000
<b>1.5 ml</b>											
∞	B-430	F A H	12.70	-	15.24	12.70	152.40	PTL-8-430	BMP61, BMP71, M611	M61-R6610	1
<b>12.0 - 24.0 ml</b>											
▲	B-499	F N A	38.10	12.70	-	-	-	PTL-29-499	BMP61, BMP71, M611	M61-R4310	500
▲	B-498	F R	38.10	12.70	-	-	-	PTL-29-498	BMP61, BMP71, M611	M61-R6210	500
▲	B-498	F R	38.10	12.70	-	-	-	BM71-29-498	BMP61, BMP71, M611	M61-R6210	5000
▶	B-461	F N A H S L	38.10	88.90	-	38.10	31.75	PTL-77-461	BMP61, BMP71, M611	M61-R4310	100
<b>14.0 - 15.0 ml</b>											
▲	B-490	F N H L	55.88	38.10	-	-	-	PTL-113-490	BMP61, BMP71, M611	M61-R4310	100
<b>50.0 ml</b>											
▲	B-423	F A	12.70	12.70	-	-	-	PTL-7-423	BMP61, BMP71, M611	M61-R6610	500
▲	B-423	F A H	12.70	12.70	-	-	-	BM71-7-423	BMP61, BMP71, M611	M61-R6010	5000
▶	B-427	F N S	19.05	38.10	-	19.05	12.70	BM71-30-427	BMP61, BMP71, M611	M61-R4300	2500
∞	B-439	F	25.40	-	15.24	-	-	PTL-42-439	BMP61, BMP71, M611	M61-R6610	1
∞	B-439	F	25.40	-	15.24	-	-	PTL-42-439-OR	BMP61, BMP71, M611	M61-R6610	1
∞	B-439	F	25.40	-	15.24	-	-	PTL-42-439-YL	BMP61, BMP71, M611	M61-R6610	1
∞	B-439	F	25.40	-	15.24	-	-	PTL-42-439-RD	BMP61, BMP71, M611	M61-R6610	1
▲	B-423	F A	25.40	4.75	-	-	-	PTL-14-423	BMP61, BMP71, M611	M61-R6610	750
▲	B-423	F A	25.40	6.99	-	-	-	PTL-15-423	BMP61, BMP71, M611	M61-R6610	750
▲	B-423	F A	25.40	12.70	-	-	-	PTL-17-423	BMP61, BMP71, M611	M61-R6610	500
▲	B-430	F A H	25.40	12.70	-	-	-	PTL-17-430	BMP61, BMP71, M611	M61-R6610	500
▲	B-498	F R	25.40	12.70	-	-	-	PTL-17-498	BMP61, BMP71, M611	M61-R6210	500
▶	B-427	F N S	25.40	38.10	-	25.40	12.70	BM71-31-427	BMP61, BMP71, M611	M61-R4300	2500
▲	B-423	F A H	25.40	50.80	-	-	-	BM71-20-423	BMP61, BMP71, M611	M61-R6010	1000
▲	B-423	F A	25.40	76.20	-	-	-	PTL-22-423	BMP61, BMP71, M611	M61-R6610	100
▲	B-499	F N A	38.10	19.05	-	-	-	PTL-30-499	BMP61, BMP71, M611	M61-R4310	250
▲	B-427	F N	38.10	19.05	-	38.10	19.05	PTL-30-427-AW*	BMP61, BMP71, M611	M61-R4310	250
▲	B-423	F A	38.10	25.40	-	-	-	PTL-31-423	BMP61, BMP71, M611	M61-R6610	250
▲	B-499	F N A	38.10	25.40	-	-	-	PTL-31-499	BMP61, BMP71, M611	M61-R4310	250
▲	B-498	F R	38.10	25.40	-	-	-	PTL-31-498	BMP61, BMP71, M611	M61-R6210	250
▲	B-490	F N H L	38.10	98.43	-	-	-	PTL-114-490	BMP61, BMP71, M611	M61-R4310	100
▲	B-488	F A	48.26	25.40	-	-	-	PTL-78-488	BMP61, BMP71, M611	M61-R4310	250
▲	B-427	F N	48.26	25.40	-	48.26	25.40	PTL-78-427-AW*	BMP61, BMP71, M611	M61-R4310	250
▲	B-499	F N A	48.26	25.40	-	48.26	25.40	PTL-78-499	BMP61, BMP71, M611	M61-R4310	250
▲	B-423	F A	50.80	25.40	-	-	-	PTL-20-423	BMP61, BMP71, M611	M61-R6610	100

\*AW = All White / no transparent area.

**i** See pages 49-53 for a detailed material index.

## Specimen process marking



### Centrifuge / microcentrifuge labels

- Brady offers a wide range of Centrifuge, Eppendorf and PCR Labels. When applying a self-laminating label, we recommend you avoid touching the adhesive side of the label when wrapping it around a vial or tube, to ensure maximum adhesion.

**F** Freezer environment  
**N** Liquid nitrogen environment  
**A** Autoclave environment  
**H** Hot water bath (100°C)  
**S** Self-laminating label  
**L** Low-profile (extremely thin) label  
**R** Removable

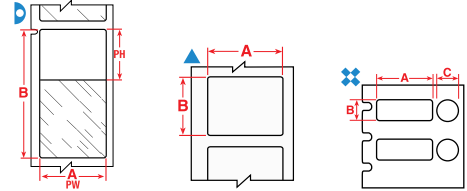

The background colours in the Order Reference column represent the material colour.

Labels are shown per vial / tube size and in order of label width.

Diagram	Material	Special Properties	Label Width A (mm)	Label Height B (mm)	Label Length B (m)	Diameter C (mm)	Printable Area Width PW (mm)	Printable Area Height PH (mm)	Order Reference	Printer Compatibility	Printer Ribbon Series	Labels per Roll
<b>0.2 ml</b>												
	B-461	F N A H S L	4.75	38.10	-	-	4.75	17.78	PTL-108-461	BMP61, BMP71, M611	M61-R4310	750
<b>0.5 ml</b>												
	B-427	F N S	25.40	63.50	-	-	25.40	19.05	PTL-21-427	BMP61, BMP71, M611	M61-R4310	100
<b>0.5 - 0.7 ml</b>												
	B-499	F N A	9.53	25.40	-	-	-	-	PTL-16-499	BMP61, BMP71, M611	M61-R4310	500
	B-498	F	9.53	25.40	-	-	-	-	PTL-16-498	BMP61, BMP71, M611	M61-R6210	500
	B-461	F N A H S L	9.53	45.72	-	-	9.53	19.05	PTL-73-461	BMP61, BMP71, M611	M61-R4310	500
	B-499	F N A	12.70	19.05	-	-	-	-	PTL-11-499	BMP61, BMP71, M611	M61-R4310	500
	B-498	F	12.70	19.05	-	-	-	-	PTL-11-498	BMP61, BMP71, M611	M61-R6210	500
	B-461	F N A H S L	12.70	45.72	-	-	12.70	19.05	PTL-72-461	BMP61, BMP71, M611	M61-R4310	500
	B-499	F N A	19.05	12.70	-	-	-	-	BM71-11-499	BMP61, BMP71, M611	M61-R4300	5000
	B-498	F	19.05	12.70	-	-	-	-	BM71-11-498	BMP61, BMP71, M611	M61-R6210	5000
	B-490	F N H L	31.75	9.53	-	-	-	-	PTL-112-490	BMP61, BMP71, M611	M61-R4310	500
<b>0.5 - 2.0 ml</b>												
	B-461	F N A H S L	12.70	55.88	-	-	12.70	19.05	PTL-74-461	BMP61, BMP71, M611	M61-R4310	100
	B-427	F N S	12.70	55.88	-	-	12.70	19.05	PTL-74-427	BMP61, BMP71, M611	M61-R4310	100
<b>0.6 - 1.5 ml</b>												
	B-499	F A	25.40	9.53	-	9.53	-	-	PTL-98-499	BMP61, BMP71, M611	M61-R4310	500
<b>1.0 - 8.0 ml</b>												
	B-461	F N A H S L	15.24	41.28	-	-	15.24	25.40	PTL-76-461	BMP61, BMP71, M611	M61-R4310	250
	B-461	F N A H S L	15.24	66.68	-	-	15.24	25.40	PTL-86-461	BMP61, BMP71, M611	M61-R4310	100
	B-499	F A	22.86	12.70	-	12.70	-	-	PTL-117-499	BMP61, BMP71, M611	M61-R4310	500
	B-490	F N H L	41.28	15.24	-	-	-	-	PTL-76-490	BMP61, BMP71, M611	M61-R4310	250



See pages 49-53 for a detailed material index.

## Specimen process marking

### Slide labels

- Brady offers labels specifically designed to identify slides and to resist exposure to harsh chemicals during the slide staining process. They perform well in the hematoxylin and eosin slide staining process and offer superior chemical resistance also useful in other laboratory contexts.

- F** Freezer environment
- N** Liquid nitrogen environment
- A** Autoclave environment
- H** Hot water bath (100°C)
- S** Self-laminating label
- L** Low-profile (extremely thin) label
- R** Removable

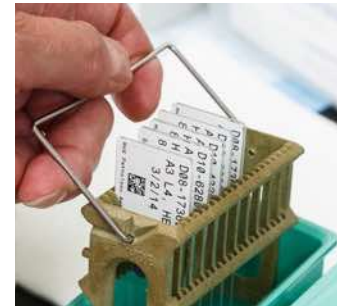

Labels are shown in order of label width.

The background colours in the Order Reference column represent the material colour.

Diagram	Material	Special Properties	Label Width A (mm)	Label Height B (mm)	Order Reference	Printer Compatibility	Printer Ribbon Series	Labels per Roll
	B-488	<b>F</b> <b>A</b>	19.05	22.86	PTL-80-488	BMP61, BMP71, M611	M61-R4310	250
	B-488	<b>F</b> <b>A</b>	22.86	22.86	PTL-97-488	BMP61, BMP71, M611	M61-R4310	250

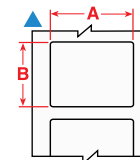

## Specimen storage identification

### Cryo tubes & vials

- Brady offers a range of labels designed specifically to identify laboratory samples for cryo storage. These labels can be applied to room temperature or to already frozen samples, albeit with a small overlap. The label will remain legible and will stick to the sample container during processing, even when exposed to extreme heat or chemicals like DMSO, Xylene and Ethanol, ensuring secure sample identification in the most challenging laboratory conditions.

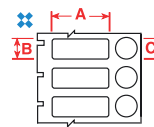
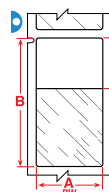
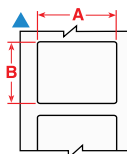

Labels are shown per vial / tube size and in order of label width.

The background colours in the Order Reference column represent the material colour.

Diagram	Material	Special Properties	Label Width A (mm)	Label Height B (mm)	Diameter C (mm)	Printable Area Width PW (mm)	Printable Area Height PH (mm)	Order Reference	Printer Compatibility	Printer Ribbon Series	Labels per Roll
<b>0.5 - 0.7 ml</b>											
	B-499	<b>F</b> <b>N</b> <b>A</b>	12.70	19.05	-	-	-	PTL-11-499	BMP61, BMP71, M611	M61-R4310	500
	B-499	<b>F</b> <b>N</b> <b>A</b>	19.05	12.70	-	-	-	BM71-11-499	BMP61, BMP71, M611	M61-R4300	5000
<b>0.5 - 2.0 ml</b>											
	B-461	<b>F</b> <b>N</b> <b>A</b> <b>H</b> <b>S</b> <b>L</b>	12.70	55.88	-	12.70	19.05	PTL-74-461	BMP61, BMP71, M611	M61-R4310	100
	B-427	<b>F</b> <b>N</b> <b>S</b>	12.70	55.88	-	12.70	19.05	PTL-74-427	BMP61, BMP71, M611	M61-R4310	100
<b>0.6 - 1.5 ml</b>											
	B-499	<b>F</b> <b>A</b>	25.40	9.53	9.53	-	-	PTL-98-499	BMP61, BMP71, M611	M61-R4310	500
<b>1.0 - 8.0 ml</b>											
	B-461	<b>F</b> <b>N</b> <b>A</b> <b>H</b> <b>S</b> <b>L</b>	15.24	41.28	-	15.24	25.40	PTL-76-461	BMP61, BMP71, M611	M61-R4310	250
	B-461	<b>F</b> <b>N</b> <b>A</b> <b>H</b> <b>S</b> <b>L</b>	15.24	66.68	-	15.24	25.40	PTL-86-461	BMP61, BMP71, M611	M61-R4310	100
	B-499	<b>F</b> <b>A</b>	22.86	12.70	12.70	-	-	PTL-117-499	BMP61, BMP71, M611	M61-R4310	500
	B-461	<b>F</b> <b>N</b> <b>A</b> <b>H</b> <b>S</b> <b>L</b>	25.40	66.68	-	25.40	25.40	PTL-75-461	BMP61, BMP71, M611	M61-R4310	100
	B-427	<b>F</b> <b>N</b> <b>S</b>	25.40	66.68	-	25.40	25.40	PTL-75-427	BMP61, BMP71, M611	M61-R4310	100
	B-461	<b>F</b> <b>N</b> <b>A</b> <b>H</b> <b>S</b> <b>L</b>	25.40	66.68	-	25.40	25.40	PTL-75-461-YL	BMP61, BMP71, M611	M61-R4310	100
	B-461	<b>F</b> <b>N</b> <b>A</b> <b>H</b> <b>S</b> <b>L</b>	25.40	66.68	-	25.40	25.40	BM71-75-461	BMP61, BMP71, M611	M61-R6210	1000
	B-490	<b>F</b> <b>N</b> <b>H</b> <b>L</b>	41.28	15.24	-	-	-	PTL-76-490	BMP61, BMP71, M611	M61-R4310	250
	B-490	<b>F</b> <b>N</b> <b>H</b> <b>L</b>	48.26	25.40	-	-	-	PTL-78-490	BMP61, BMP71, M611	M61-R4310	250
<b>12.0 - 24.0 ml</b>											
	B-461	<b>F</b> <b>N</b> <b>A</b> <b>H</b> <b>S</b> <b>L</b>	19.05	95.25	-	19.05	25.40	PTL-79-461	BMP61, BMP71, M611	M61-R4310	100
	B-498	<b>F</b>	<b>R</b> 38.10	12.70	-	-	-	PTL-29-498	BMP61, BMP71, M611	M61-R6210	500
	B-498	<b>F</b>	<b>R</b> 38.10	12.70	-	-	-	BM71-29-498	BMP61, BMP71, M611	M61-R6210	5000
	B-461	<b>F</b> <b>N</b> <b>A</b> <b>H</b> <b>S</b> <b>L</b>	38.10	88.90	-	38.10	31.75	PTL-77-461	BMP61, BMP71, M611	M61-R4310	100

## Specimen storage identification



### Well plate labels

- When total tracking of all sample collections is required then Brady has a solution for Well plate identification. Our well plate labels guarantee crystal clear text and barcoding for most lab environments.

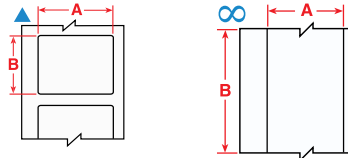

- F** Freezer environment
- N** Liquid nitrogen environment
- A** Autoclave environment
- H** Hot water bath (100°C)
- S** Self-laminating label
- L** Low-profile (extremely thin) label
- R** Removable

Labels are shown in order of label width.

The background colours in the Order Reference column represent the material colour.

Diagram	Material	Special Properties	Label Width A (mm)	Label Height B (mm)	Label Length B (m)	Printable Area Width PW (mm)	Printable Area Height PH (mm)	Order Reference	Printer Compatibility	Printer Ribbon Series	Labels per Roll
∞	B-430	F A H	12.70	-	15.24	12.70	152.40	PTL-8-430	BMP61, BMP71, M611	M61-R6610	1
▲	B-423	F A	12.70	12.70	-	-	-	PTL-7-423	BMP61, BMP71, M611	M61-R6610	500
▲	B-423	F A H	12.70	12.70	-	-	-	BM71-7-423	BMP61, BMP71, M611	M61-R6010	5000
∞	B-439	F	25.40	-	15.24	-	-	PTL-42-439	BMP61, BMP71, M611	M61-R6610	1
∞	B-439	F	25.40	-	15.24	-	-	PTL-42-439-OR	BMP61, BMP71, M611	M61-R6610	1
∞	B-439	F	25.40	-	15.24	-	-	PTL-42-439-YL	BMP61, BMP71, M611	M61-R6610	1
∞	B-439	F	25.40	-	15.24	-	-	PTL-42-439-RD	BMP61, BMP71, M611	M61-R6610	1
▲	B-423	F A	25.40	4.75	-	-	-	PTL-14-423	BMP61, BMP71, M611	M61-R6610	750
▲	B-423	F A	25.40	6.99	-	-	-	PTL-15-423	BMP61, BMP71, M611	M61-R6610	750
▲	B-423	F A	25.40	12.70	-	-	-	PTL-17-423	BMP61, BMP71, M611	M61-R6610	500
▲	B-430	F A H	25.40	12.70	-	-	-	PTL-17-430	BMP61, BMP71, M611	M61-R6610	500
▲	B-498	F R	25.40	12.70	-	-	-	PTL-17-498	BMP61, BMP71, M611	M61-R6210	500
▲	B-423	F A	25.40	76.20	-	-	-	PTL-22-423	BMP61, BMP71, M611	M61-R6610	100
▲	B-499	F N A	38.10	12.70	-	-	-	PTL-29-499	BMP61, BMP71, M611	M61-R4310	500
▲	B-498	F R	38.10	12.70	-	-	-	PTL-29-498	BMP61, BMP71, M611	M61-R6210	500
▲	B-498	F R	38.10	12.70	-	-	-	BM71-29-498	BMP61, BMP71, M611	M61-R6210	5000
▲	B-499	F N A	38.10	19.05	-	-	-	PTL-30-499	BMP61, BMP71, M611	M61-R4310	250
▲	B-427	F N	38.10	19.05	-	38.10	19.05	PTL-30-427-AW*	BMP61, BMP71, M611	M61-R4310	250
▲	B-423	F A	38.10	25.40	-	-	-	PTL-31-423	BMP61, BMP71, M611	M61-R6610	250
▲	B-499	F N A	38.10	25.40	-	-	-	PTL-31-499	BMP61, BMP71, M611	M61-R4310	250
▲	B-498	F R	38.10	25.40	-	-	-	PTL-31-498	BMP61, BMP71, M611	M61-R6210	250
▲	B-490	F N H L	38.10	98.43	-	-	-	PTL-114-490	BMP61, BMP71, M611	M61-R4310	100
▲	B-488	F A	48.26	6.35	-	-	-	PTL-81-488	BMP61, BMP71, M611	M61-R4310	750
▲	B-499	F N A	48.26	6.35	-	48.26	6.35	PTL-81-499	BMP61, BMP71, M611	M61-R4310	750
▲	B-488	F A	48.26	25.40	-	-	-	PTL-78-488	BMP61, BMP71, M611	M61-R4310	250
▲	B-427	F N	48.26	25.40	-	48.26	25.40	PTL-78-427-AW*	BMP61, BMP71, M611	M61-R4310	250
▲	B-499	F N A	48.26	25.40	-	48.26	25.40	PTL-78-499	BMP61, BMP71, M611	M61-R4310	250
▲	B-423	F A	50.80	6.35	-	-	-	PTL-2-423	BMP61, BMP71, M611	M61-R6610	100
▲	B-423	F A	50.80	25.40	-	-	-	PTL-20-423	BMP61, BMP71, M611	M61-R6610	100
▲	B-490	F N H L	55.88	38.10	-	-	-	PTL-113-490	BMP61, BMP71, M611	M61-R4310	100

\*AW = All White / no transparent area.

## Lean lab identification

- F** Freezer environment
- N** Liquid nitrogen environment
- A** Autoclave environment
- H** Hot water bath (100°C)
- S** Self-laminating label
- L** Low-profile (extremely thin) label
- R** Removable

## Bottles / flasks & dishes

- Brady's labels for bottles, flasks and dishes are easy to handle and flexible. This enables the labels to be placed on curved containers and remain attached and legible, even after being subjected to freezing, liquid nitrogen and heat.

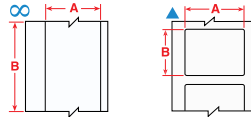

Labels are shown in order of label width.

The background colours in the Order Reference column represent the material colour.

Diagram	Material	Special Properties	Label Width A (mm)	Label Height B (mm)	Label Length B (m)	Printable Area Width PW (mm)	Printable Area Height PH (mm)	Order Reference	Printer Compatibility	Printer Ribbon Series	Labels per Roll
∞	B-430	F A H	12.70	-	15.24	12.70	152.40	PTL-8-430	BMP61, BMP71, M611	M61-R6610	1
▲	B-423	F A	12.70	12.70	-	-	-	PTL-7-423	BMP61, BMP71, M611	M61-R6610	500
▲	B-498	F R	12.70	12.70	-	-	-	PTL-7-498	BMP61, BMP71, M611	M61-R6210	500
▲	B-423	F A H	12.70	12.70	-	-	-	BM71-7-423	BMP61, BMP71, M611	M61-R6010	5000
▲	B-499	F N A	12.70	12.70	-	12.70	12.70	PTL-7-499	BMP61, BMP71, M611	M61-R4310	500
▲	B-432	F A	19.05	12.70	-	-	-	PTL-11-432	BMP61, BMP71, M611	M61-R6610	500
▲	B-499	F N A	22.86	12.70	-	-	-	PTL-84-499	BMP61, BMP71, M611	M61-R4310	500
∞	B-439	F	25.40	-	15.24	-	-	PTL-42-439	BMP61, BMP71, M611	M61-R6610	1
∞	B-439	F	25.40	-	15.24	-	-	PTL-42-439-OR	BMP61, BMP71, M611	M61-R6610	1
∞	B-439	F	25.40	-	15.24	-	-	PTL-42-439-YL	BMP61, BMP71, M611	M61-R6610	1
∞	B-439	F	25.40	-	15.24	-	-	PTL-42-439-RD	BMP61, BMP71, M611	M61-R6610	1
▲	B-423	F A	25.40	4.75	-	-	-	PTL-14-423	BMP61, BMP71, M611	M61-R6610	750
▲	B-423	F A	25.40	6.99	-	-	-	PTL-15-423	BMP61, BMP71, M611	M61-R6610	750
▲	B-432	F A	25.40	12.70	-	-	-	PTL-17-432	BMP61, BMP71, M611	M61-R6610	500
▲	B-423	F A	25.40	12.70	-	-	-	PTL-17-423	BMP61, BMP71, M611	M61-R6610	500
▲	B-430	F A H	25.40	12.70	-	-	-	PTL-17-430	BMP61, BMP71, M611	M61-R6610	500
▲	B-7351	F	25.40	12.70	-	-	-	PTL-17-7351	BMP61, BMP71, M611	M61-R6010	500
▲	B-498	F R	25.40	12.70	-	-	-	PTL-17-498	BMP61, BMP71, M611	M61-R6210	500
▲	B-423	F A H	25.40	50.80	-	-	-	BM71-20-423	BMP61, BMP71, M611	M61-R6010	1000
▲	B-423	F A	25.40	76.20	-	-	-	PTL-22-423	BMP61, BMP71, M611	M61-R6610	100
▲	B-499	F N A	38.10	12.70	-	-	-	PTL-29-499	BMP61, BMP71, M611	M61-R4310	500
▲	B-498	F R	38.10	12.70	-	-	-	PTL-29-498	BMP61, BMP71, M611	M61-R6210	500
▲	B-499	F N A	38.10	19.05	-	-	-	PTL-30-499	BMP61, BMP71, M611	M61-R4310	250
▲	B-427	F N	38.10	19.05	-	38.10	19.05	PTL-30-427-AW*	BMP61, BMP71, M611	M61-R4310	250
▲	B-490	F N H L	38.10	98.43	-	-	-	PTL-114-490	BMP61, BMP71, M611	M61-R4310	100
▲	B-488	F A	48.26	25.40	-	-	-	PTL-78-488	BMP61, BMP71, M611	M61-R4310	250
▲	B-427	F N	48.26	25.40	-	48.26	25.40	PTL-78-427-AW*	BMP61, BMP71, M611	M61-R4310	250
▲	B-499	F N A	48.26	25.40	-	48.26	25.40	PTL-78-499	BMP61, BMP71, M611	M61-R4310	250
▲	B-7351	F	48.26	76.20	-	-	-	PTL-37-351	BMP61, BMP71, M611	M61-R6010	100
▲	B-423	F A	50.80	25.40	-	-	-	PTL-20-423	BMP61, BMP71, M611	M61-R6610	100
▲	B-7351	F	50.80	25.40	-	-	-	PTL-20-7351	BMP61, BMP71, M611	M61-R6010	100
▲	B-490	F N H L	55.88	38.10	-	-	-	PTL-113-490	BMP61, BMP71, M611	M61-R4310	100

\*AW = All White / no transparent area.



See pages 49-53 for a detailed material index.

## Lean lab identification

- F** Freezer environment
- N** Liquid nitrogen environment
- A** Autoclave environment
- H** Hot water bath (100°C)
- S** Self-laminating label
- L** Low-profile (extremely thin) label
- R** Removable

### Water dissolvable labels

The B-403 water dissolvable paper label is self-adhesive and extremely easy to apply. Exposing the label to warm water will completely dissolve it within 30 seconds, without damage to the surface it was applied to, and without leaving any residue. The water dissolvable label adheres well to most surfaces, including glass, stainless steel, aluminium, plastic and others. This makes the label a great solution to enable short term identification for containers, crates and glassware with a minimum of waste.

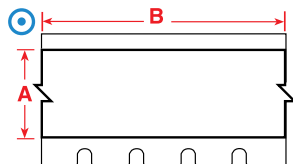

The background colours in the Order Reference column represent the material colour.

Diagram	Material	Special Properties	Label Width A (mm)	Label Length B (m)	Order Reference	Printer Compatibility	Printer Ribbon Series	Labels per Roll
⊙	B-403	<b>R</b>	19.05	15.25	M61C-750-403	M611; BMP61, M611	R6400	1
⊙	B-403	<b>R</b>	38.10	15.25	M61C-1500-403	M611; BMP61, M611	R6400	1

This section provides a quick reference to Brady materials listed throughout this catalogue, including basic attributes, applications and regulatory compliance where applicable. For more detailed material attribute and performance information, please refer to the material's Technical Data Sheet, listed at [www.bradyeurope.com/tds](http://www.bradyeurope.com/tds).

Brady Material No.	Material	Finish	Colour	Temp (°C) (Tested for 30 days)		Performance Attributes	Properties & Applications	Approval/Compliance
				Min.	Max.			
B-109	Polyethylene Tag	Matt	White	-40 °C	49 °C		White polyethylene tag material with matt finish. Excellent multi-purpose tag for identifying multiconductor cables, inventory, safety warning repair and work-in-processing manufacturing. Good weatherability, humidity resistance and legibility after solvent exposure.	–
B-145	Polyethylene Tag	Matt	Grey	-40 °C	100 °C		This multipurpose material can be used for a variety of tag applications including identification of multiconductor cables, equipment, safety warning repair and workinprogress.	–
B-321	Heat-shrink Polyolefin Sleeve	Matt	White	-40 °C	120 °C		Heat-shrinkable; excellent resistance to oil and solvents. Ink-receptive coating provides permanent legibility. Applications requiring sleeve markers, computer-printable.	Meets MIL-M-81531; MIL-STD-202, Method 215J
B-342	Heat-shrink Polyolefin Sleeve	Matt	White	-55 °C	130.6 °C		3:1 ratio heat shrinkable wire marking sleeve that fits snugly around wires for identification and protection. Fade-resistant and flame retardant. Also available in yellow and black.	UL Recognised to UL224; SAE-AMS-DTL-23053/5 C (Class 1); SAE-AS-81531
B-345	High Temperature Heat-shrink Polyvinylidene Fluoride Sleeve	Matt	White	-70 °C	130.6 °C		2:1 ratio heat shrinkable wire marking sleeve specifically designed for high temperature and low vacuum outgassing applications. These heat shrinkable wire marking sleeves are made from irradiated high temperature PVDF. Also available in black.	NASA SP-R-0022A Outgassing Performance; SAE-AMS-DTL-23053/18 (Class 2); SAE-AS-81531; MIL-STD-202G Method 215K
B-362	Tamper-resistant Metallised Vinyl	Gloss	Silver	-70 °C	80 °C		Designed to fracture easily in order to show signs of product tampering and to prevent one-piece label removal. Use caution when removing from liner as material is fragile.	–
B-390	Rigid Insert	Matt	White	-40 °C	100 °C		Designed to be printed and affixed to a wire using extruded, clear PVC Brady Wire Marking Carriers.	Halogen Free (DIN VDE 0472/part 815)
B-403	Paper	Matt	White	-40 °C	78 °C			–
B-412	Polypropylene Tag	Matt	White	-40 °C	100 °C		White polypropylene tag material with matt finish. Offers high print legibility and high tensile strength.	–
B-422	Polyester	Gloss	White	-40 °C	100 °C		Designed to withstand solvent exposure. Used for component identification, barcoding, asset and inventory tracking.	UL Recognised; CSA Accepted
B-422/B-966B	Polyester	Gloss	White	-40 °C	100 °C		Supplied with a separate overlamine mounted onto the liner underneath the label to allow for the label to be printed first.	–
B-423	Polyester	Gloss	White	-70 °C	110 °C		Widely used for component identification, barcoding, asset and inventory tracking.	UL Recognised; CSA Accepted; AGA Approved; Halogen Free (DIN VDE 0472/part 815)

**i** For more information about our product performance icons, see page 14.



WorkHorse™ Labels



MetaLabel™ Series



ToughBond™ Series



Defender™ Series



CleanLift™ Series



UltraTemp™ Series



Abrasion resistance



Electrostatic dissipative



Fuel/oil resistance



High heat resistance



Low temperature resistance



Removable



Solvent/chemical resistance



Tamper-indicating



Ultra-aggressive adhesive

# Master material index

Brady Material No.	Material	Finish	Colour	Temp (°C) (Tested for 30 days)		Performance Attributes	Properties & Applications	Approval/Compliance
				Min.	Max.			
B-424	Paper	Matt	White	-40 °C	50 °C			–
B-424/B-966B	Paper with Polyester Overlaminates	Gloss	White				Supplied with a separate overlaminates mounted onto the liner underneath the label to allow for the label to be printed first.	–
 B-425A	Polypropylene	Matt	White	-70 °C	80 °C	  	White polypropylene material stock with matt finish for thermal transfer printing or write-on applications. Excellent solvent resistance and print performance; not recommended for long-term outdoor use.	UL Recognised; CSA Accepted; Halogen Free (DIN VDE 0472/part 815)
B-427	Self-laminating Vinyl	Matt	White/Transparent	-40 °C	60 °C		Thermal transfer printable, self-laminating material. These labels have a printable area with a clear "tail" that wraps around the marker. The "tail" serves as overlaminates to protect the print. Superior resistance to abrasion, solvents, water, oil and dirt. Also available in grey, brown, green, yellow, blue, red, purple, orange	UL Recognised to UL969 Labelling and Marking Standard when printed with the Brady Series R4300 and R6200 ribbons. See UL files MH17154 for specific details. Brady customers should specify at purchase if they require UL Recognised B-427 labels. Brady sells both UL Recognised B-427 labels and non-approved labels depending on customer requirements.
 B-428	Metallised Polyester	Matt	Silver	-70 °C	120 °C	  	Thermal transfer printable metallised polyester with matt finish. Withstands solvents and variable temperatures. Excellent for serial and rating plate applications with name-plate quality and a metal-looking finish.	UL Recognised; CSA Accepted; Halogen Free (DIN VDE 0472/part 815)
B-428/B-966	Metallised Polyester with Polyester Overlaminates	Gloss	Silver	-70 °C	120 °C		A Metallised polyester label that comes with a separate overlaminates to be applied over the label once printed. This way the label remains clear and easy-to-read, even in harsh environments. Overlaminates is a clear polyester (B-966B) that extends outside of label on each side when applied.	–
 B-430	Polyester	Gloss	Clear	-70 °C	100 °C	  	Translucent, high performance polyester material with a glossy finish. Thermal transfer printable.	UL Recognised; CSA Accepted
B-432	Polyester	Gloss	Clear	-40 °C	100 °C		Translucent, high performance polyester material with a glossy finish. Thermal transfer printable. Very similar to B-430, but has a thicker layer of acrylic adhesive for better adherence to rough surface applications.	UL Recognised; CSA Accepted
 B-435	Metallised Polyester	Gloss	Silver	-40 °C	90 °C	  	Printable metallised polyester withstands numerous solvents and variable temperatures. Ideal for serial and rating plate applications with name-plate quality and a metal looking finish.	UL Recognised; CSA Accepted

**i** For more information about our product performance icons, see page 14.



WorkHorse™  
Labels



MetaLabel™  
Series



ToughBond™  
Series



Defender™  
Series



CleanLift™  
Series



UltraTemp™  
Series

  
Abrasion  
resistance

  
Electrostatic  
dissipative

  
Fuel/oil  
resistance

  
High heat  
resistance

  
Low  
temperature  
resistance

  
Removable



  
Solvent/  
chemical  
resistance

  
Tamper-  
indicating

  
Ultra-  
aggressive  
adhesive



# Master material index

Brady Material No.	Material	Finish	Colour	Temp (°C) (Tested for 30 days)		Performance Attributes	Properties & Applications	Approval/Compliance
				Min.	Max.			
 B-717	Polyimide	Gloss	White	-70 °C	300 °C		White polyimide material with glossy finish and ultra-durable adhesive. Used in printed circuit board and electronic component pre-process labelling. Designed for use with extreme wash protocol and cleaning chemicals. Surface resistivity values in the recommended range for dissipative ESD packing materials.	UL Recognised; Meets the requirements of ANSI/ESD S541-2008 (between 10 <sup>4</sup> and 10 <sup>11</sup> ohms) for dissipative ESD packaging materials; Meets the performance requirements of MIL-STD-202G, Method 215K
 B-718	Polyimide	Gloss	White	-70 °C	300 °C		White polyimide material, low profile (1 mil thickness), with glossy finish and ultra-durable adhesive. Used in printed circuit board and electronic component pre-process labelling. Designed for use with extreme wash protocol and cleaning chemicals. Surface resistivity values in the recommended range for dissipative ESD packing materials.	UL Recognised; Meets the requirements of ANSI/ESD S541-2008 (between 10 <sup>4</sup> and 10 <sup>11</sup> ohms) for dissipative ESD packaging materials; Meets the performance requirements of MIL-STD-202G, Method 215K
 B-719	Polyimide	Matt	White	-70 °C	300 °C		White polyimide material with matt finish and ultra-durable adhesive. Used in printed circuit board and electronic component pre-process labelling. Designed for use with extreme wash protocol and cleaning chemicals. Surface resistivity values in the recommended range for dissipative ESD packing materials.	UL Recognised; Meets the requirements of ANSI/ESD S541-2008 (between 10 <sup>4</sup> and 10 <sup>11</sup> ohms) for dissipative ESD packaging materials; Meets the performance requirements of MIL-STD-202G, Method 215K
 B-724	Polyimide	Matt	Amber	-70 °C	300 °C		Amber polyimide material with matt finish and ultra-durable adhesive. Used in printed circuit board and electronic component pre-process labelling. Designed for use with extreme wash protocol and cleaning chemicals.	Meets the performance requirements of MIL-STD-202G, Notice 12, Method 215K; Meets the requirements of SAE AS81531 Marking of Electrical Insulating Material
 B-727	Polyimide	Gloss	White	-70 °C	300 °C		White polyimide material with glossy finish and ultra-durable adhesive. Used in printed circuit board and electronic component pre-process labelling. Designed for use with extreme wash protocol and cleaning chemicals.	UL Recognised; Meets the performance requirements of MIL-STD-202G, Notice 12, Method 215K; Dibutyltin and Dioctyltin free.
 B-7351	Tamper-resistant Vinyl	Satin	White	-40 °C	80 °C		White vinyl material with matt finish. Tamper evident material fractures to show signs of product tampering and prevent one-piece removal.	–
B-7425	Polypropylene	Matt	Black on White	-80 °C	70 °C		White Polypropylene material. Ideal for laboratory identification such as vials, centrifuge tubes and test tubes. For freezer or liquid nitrogen applications, B-7425 must be applied prior to being frozen.	–
 B-7546	Tamper-evident Polyester	Gloss	White	-20 °C	100 °C		White polyester material with glossy finish. Leaves a "VOID" footprint on the surface. The adhesive does not allow for repositioning to prevent it from being reused.	UL Recognised; CSA Accepted
B-7551	Polyester	Matt	Clear	-20 °C	70 °C			–
 B-7576	Tamper-evident Metallised Polyester	Matt	Silver	-70 °C	100 °C		Metallised polyester material with matt finish. Leaves a "VOID" footprint on the surface when removed; the pattern also appears on the top of the label to prevent it from being reused.	UL Recognised
B-7593	Polyethylene Foam Laminate Polyester	Gloss	White	-40 °C	100 °C		Thermal transfer printable raised panel labels. Designed to make legend plate creation quick, less expensive, and hassle free! Use for electrical components, electrical cabinets, push buttons, patch panels, and any other applications you can imagine. This material can also be used for rating and serial plates using alphanumerics that require name plate quality. Also available in black, green, red, silver and yellow	–
B-7597	Polyethylene Tag	Matt	White	-40 °C	100 °C		Polyethylene tag material. Resists tearing and the topcoat resists smudging and abrasion. Halogen free material. Also available in yellow.	Halogen Free (DIN VDE 0472/part 815)

Brady Material No.	Material	Finish	Colour	Temp (°C) (Tested for 30 days)		Performance Attributes	Properties & Applications	Approval/Compliance
				Min.	Max.			
B-7598	Polyester Tag	Gloss	White, Yellow, Red, Green, Silver, Black, Blue	-40 °C	100 °C		A general identification polyester tag for cables exposed to extreme conditions. Up to 10 years outdoor durability. Also available in black, blue, green, red, silver and yellow.	Parts supplied in White, Black or Silver are Halogen Free as per IEC 61249-2-21 (2003-11)
B-7599	Polyethylene Tag	Matt	Yellow	-40 °C	50 °C		White polyethylene tag material. Rapido™ Wiremarking Sleeves are fast and easy to apply. Simply squeeze the edges of the material together, thread your wire through the holes and pull away the wire to release the marker.	–
B-7643	Thermoplastic Polyether Polyurethane	Matt	White, Yellow	-40 °C	90 °C		Thermal transfer and dot matrix printable wire and cable bundle tag for harsh environments. Low halogen material. Also available in black, orange, red and yellow.	Halogen free per IEC 61249-2-21 (2003-11), Adherence: SAE-AS81531-1998, Flame retardant: MIL-STD-202G
B-7644	Polypropylene Tag with Polyester Overlaminat	Gloss	Yellow	-70 °C	150 °C		Laminate carrier for cable identification with strip to laminate text label. The carrier is to be fixed with 2 cable ties directly on the cables and wires.	–
B-7645	Polypropylene Tag with Polyester Overlaminat	Gloss	Yellow	-70 °C	150 °C		Self-sealing tags for identification of material in tough environments, including valves, instruments, motors and other industrial components. Laminat™ tags can be delivered with a stainless steel reinforcement ring.	–
B-7696	Vinyl Tag	Gloss	White	-40 °C	70 °C		Brady DuraSleeve® printable inserts create a durable legend. The rigid construction of the DuraSleeve wire marking system provides inserts that can easily be inserted into a clean carrier. The legend can be changed before or after termination. Also available in yellow.	UL94 V0
B-7697	Polyester Tag	Matt	White	-40 °C	120 °C			–



For more information about our product performance icons, see page 14.



WorkHorse™  
Labels



MetaLabel™  
Series



ToughBond™  
Series



Defender™  
Series



CleanLift™  
Series



UltraTemp™  
Series



Abrasion  
resistance



Electrostatic  
dissipative



Fuel/oil  
resistance



High heat  
resistance



Low  
temperature  
resistance



Removable



Solvent/  
chemical  
resistance



Tamper-  
indicating



Ultra-  
aggressive  
adhesive

## Design any label with Brady Workstation apps



Brady Workstation offers professional, intuitive apps to design quality product and cable labels and safety signs. Label design becomes easier, faster and quickly adaptable to new label norms thanks to centralised updates.

### Select the apps you need

Simply select the apps you need, download the 30-day trial and purchase when satisfied.



Try it today! Discover Brady Workstation at [www.bradyeurope.com/workstation](http://www.bradyeurope.com/workstation) or download at [workstation.bradyid.com](http://workstation.bradyid.com).



### Brady Workstation Basic Design Software Suite

Get everyone in your facility up and running quickly on as many computers as you like with this free label creation software! You'll have basic design, formatting, graphics and simple barcode libraries to create labels like a pro!

The Basic Suite is included with every printer, all you need to do is download it.

**[Workstation.BradyID.com/Free](http://Workstation.BradyID.com/Free)**



### Brady Workstation Product and Wire Identification Software Suite

Quickly identify your products and wires with customised text or graphical labels, using serialised or imported data. **[Workstation.BradyID.com/ProductandWire](http://Workstation.BradyID.com/ProductandWire)**

## Print Partner Mobile & Text Label apps

The rugged, portable BMP61 is also available in a wifi-enabled version compatible with Brady mobile apps. Simply create or send label designs from a smart phone to the printer for extremely fast and easy label creation on the job.



### Brady Text Labels app\*

- Enter the label cartridge number currently in your BMP61 Label Printer
- Enter your text
- Hit print



### Brady Print Partner app\*

- Download an existing label design from your inbox or storage system
- Complete the predefined label data fields with your smartphone
- Hit print

\*BMP61 Label Printer wifi version required

## Brady Workstation Express Labels App

### Keep printing everywhere

Forget the days of wasting time driving back and forth between the office and the jobsite to get new labels for every identification project. The complete BradyPrinter M611 Mobile Printer and Brady Workstation Software solution bridges the printing gap between the office and the field. With this combination of mobile software and mobile print connectivity, you get the freedom to push data from the office to the field so your field engineers have everything they need to complete the task at hand. After the job is complete, rely on the high-performance of Brady materials to provide long-lasting identification.

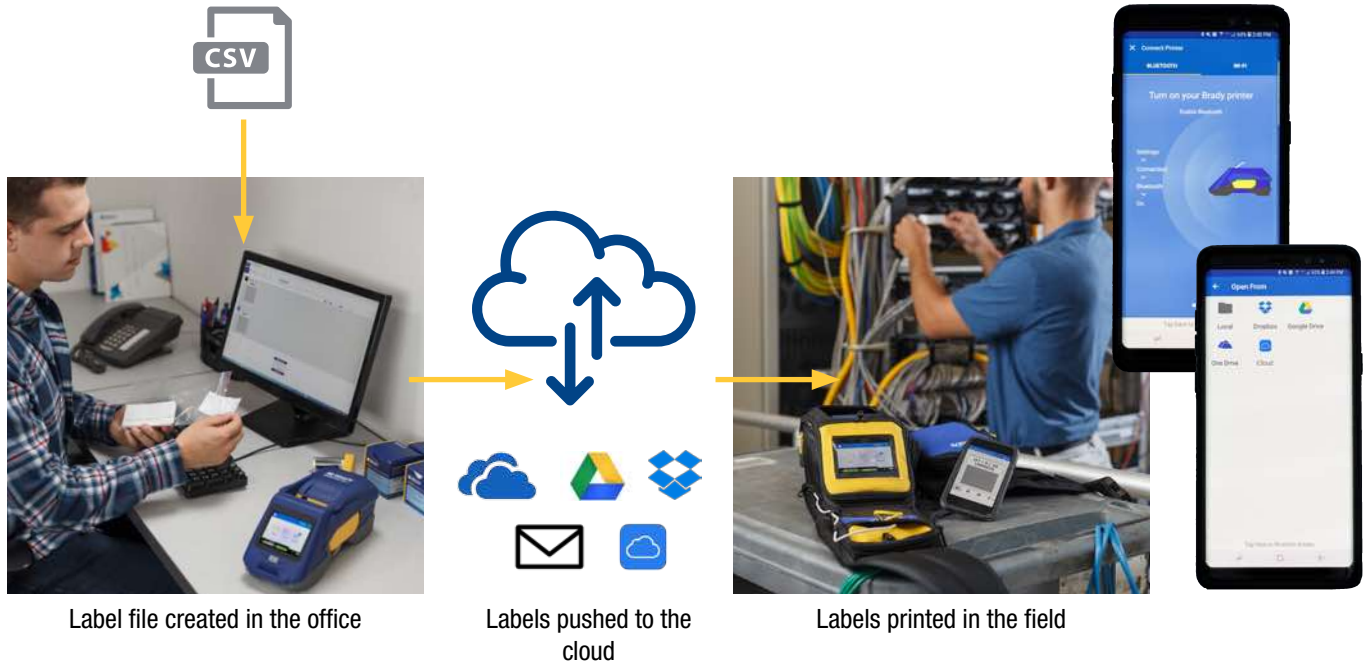

**i** Try it today! Discover the Brady Workstation mobile apps on [www.bradyeurope.com/BradyWorkstationMobile](http://www.bradyeurope.com/BradyWorkstationMobile)

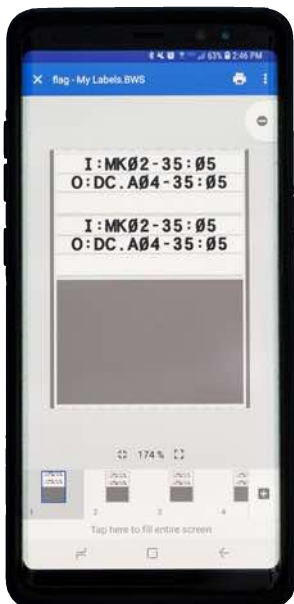

### Your one-stop shop for mobile printing

The Brady Workstation Express Labels App makes mobile printing convenient and simple. This intuitively designed software integrates touchscreen technology for fast and easy label creation, including label resizing using touch and a native keyboard for more natural typing. To make label creation even more convenient, the app features auto-save capabilities, tools to help you easily enter data onto your label, and easy-to-use editing tools to keep labeling projects moving smoothly.

With our Express app installed, you can easily design complex labels with 1D and 2D codes and barcodes, serialise, use an extensive image library, include text, a time stamp and even data from the cloud. The Express app offers the most comprehensive label design capabilities available for any smartphone and includes design wizards to quickly create specific identification labels.

**i** Get the free app from Apple App Store or Google Play (Search "Brady Express Labels")



Apple App Store



Google Play

# BMP61 Label Printer specifications

PRINTER	
Description	BMP61 Label Printer
Includes	This printer ships in a hard case holding a USB cable, a quick start guide, a battery pack, an AC Adapter, a CD with driver, a product CD, a hand strap, a Brady Workstation Suite, a roll of PTL-19-423 and an M61-R6010 ribbon
Applications	Wire & Cable Marking; General & Industrial Identification; Asset Identification; Terminal Block identification; Voice & Data Identification; Rating plate Identification; Patch panel identification; Electrical Component Marking; Control panel and component marking; Circuit Board & Component Identification
Print Speed (mm/sec)	33.8
Internal Memory Capacity	512MB of FLASH storage and 512MB of RAM
Cutter	Manual cut Between labels or at end of print job
Keyboard Type	QWERTY, QWERTZ, AZERTY, CYRILLIC
Colour Capability	Monocolour
Language Support	Bulgarian, Croatian, Czech, Danish, Dutch, English, Estonian, Finnish, French, German, Hungarian, Italian, Norwegian (Bokmål), Polish, Portuguese, Romanian, Russian, Slovak, Slovenian, Spanish, Swedish, Turkish
Portability	Yes
Weight (kg)	1.5
Size W x D x L (mm)	107 x 106 x 328
Drop Test	up to 1.2 metres
Operating Temperature	5°C - 40°C
Operating Humidity	10%-90% (non-condensing)
Storage Temperature	-30° to 60° C
Storage Humidity	10%-90% (non-condensing)
Warranty	2 years

MEDIA SUPPORTED	
Materials Supported	600+ standard parts: continuous tapes, die cut and bulk label rolls, custom made labels and tapes.
Format	Ribbon and Tape separate, also bulk rolls
Continuous vs Die-cut Labels	Continuous Tape & Die Cut Labels
Custom Labels	Yes
Smart Cell	Yes
Label Dimensions	Various sizes from 6.4mm to 50.8mm
Max. Label Width (mm)	50.80
Min. Label Width (mm)	6.4
Min. Label Height (mm)	5.99
Max. Liner Width (mm)	57
Min. Liner Width (mm)	20.62
Recommended Usage per Day	750 labels per day

POWER SUPPLY	
Auto Shut Off	Yes
Battery Type	Rechargeable NiMH Battery
Power Supply	AC Adaptor Rechargeable Battery

DISPLAY	
Display	Colour Touchscreen
Display Resolution	320 x 240 px

FONTS/GRAPHICS/SYMBOLOGIES	
Max. Lines of Text	25
Text Sizes (pt)	4 - 174 pt
Built-in Fonts	Brady Alpine Brady Fixed Width
Built-in Symbols	450 symbols included
Bar Code Capability	Yes
Bar Code Type	Code 39 and 128, other via software

PRINTING FUNCTIONS	
Serialisation	Multiple & Linked
Print Resolution (dpi)	300

SOFTWARE & CONNECTIVITY	
Connectivity Options	USB 2.0, USB Flash Drive, Optional WiFi (factory installed)
Software Compatibility	Brady Workstation, Brady Mobile Apps, LabelMark

COMPLIANCE	
Approval/Compliance	UL; cul: CE; RoHS; EAC; ICASA





**BMP61**  
LABEL PRINTER

For videos and more information, scan or click the QR code.



PRINTER	
Description	M611 Label Printer
Includes	This printer ships in a cardboard box holding a USB cable, a quick start guide, an AC powercord, a USB stick holding product info and Windows driver, a strap, a Brady Workstation Suite, a roll of PTL-97-488 and an M61-R4310 ribbon
Applications	Wire & Cable Marking; General & Industrial Identification; Asset Identification; Terminal Block ID; Voice & Data Identification; Rating plate Identification; Patch panel identification; Electrical Component Marking; Laboratory Identification; Control panel and component marking; Circuit Board & Component Identification
Print Speed (mm/sec)	33.8
Internal Memory	256 MB Flash; 512 MB RAM
Cutter	Auto Cutter
Keyboard Type	None
Colour Capability	Monocolour
Language Support	Bulgarian, Croatian, Czech, Danish, Dutch, English, Estonian, Finnish, French, German, Hungarian, Italian, Norwegian (Bokmål), Polish, Portuguese, Romanian, Russian, Slovak, Slovenian, Spanish, Swedish, Turkish
Portability	Yes
Weight (kg)	1.6
Size W x D x L (mm)	113 x 279 x 115
Drop Test	up to 1.2 metres
Operating Temperature	5°C - 40°C
Operating Humidity	10%-90% (non-condensing)
Calibration	Automated through Smart Cell
Warranty	2 years

MEDIA SUPPORTED	
Materials Supported	800+ standard parts: continuous tapes, die cut and bulk label rolls, custom made labels and tapes.
Compatible Media	BM71-(bulk), M71-, M61C-, M61-, PSPT-, PTDSU-, PTDS-, PSHT-, PTL-, PTS-, BM61-(bulk), BM61D-, BM61C-, BM61E-, PTLEP-
Format	Ribbon and Tape separate, also bulk rolls
Continuous vs Die-cut Labels	Continuous Tape & Die Cut Labels
Custom Labels	Yes
Smart Cell	Yes
Label Dimensions	Various sizes from 6.4mm to 50.8mm
Max. Label Width (mm)	50.80 mm
Min. Label Width (mm)	6.4 mm
Min. Label Height (mm)	5.99
Max. Liner Width (mm)	57
Min. Liner Width (mm)	20.62
Recommended Usage per Day	750 labels per day

POWER SUPPLY	
Auto Shut Off	Yes
Battery Type	Rechargeable Lithium Ion Battery
Power Supply	AC Adaptor Rechargeable Battery

DISPLAY	
Display	Colour LCD Touchscreen
On Screen Indicators	Battery Life Ribbon and label part number recognition Supply Remaining Bluetooth Status Error Messaging WiFi
Display Resolution	320 x 240 px

FONTS/GRAPHICS/SYMBOLOGIES	
Built-in Fonts	See Brady Workstation
Bar Code Capability	Yes
Bar Code Type	Code 39 and 128, other via software

PRINTING FUNCTIONS	
Print Resolution (dpi)	300

SOFTWARE & CONNECTIVITY	
Connectivity Options	Bluetooth, USB, WiFi
Software Compatibility	Brady Workstation Express Labels Mobile App

COMPLIANCE	
Approval/Compliance	CE 2014/53/EU RED, 2014/35/EU LVD, 2014/30/EU EMCD, 2011/65/EU, RoHS, UL 60950-1 2nd Edition, EN \ IEC 60950-1:2006 + A11:2009 + A1:2010 + A12:2011 + A2:2013, EN \ IEC 62368-1:2014, WEEE



**i**  For more information on the Express app, see page 55.

**i**   **BradyPrinter M611**  
MOBILE LABEL PRINTER

For videos and more information, scan or click the QR code.



## Printers



Order Reference	Art. No.	Description
BMP61-QWERTZ-EU-W	146224	BMP61 Label Printer - QWERTZ with wifi
BMP61-W	146226	BMP61 Label Printer - QWERTY US with wifi
BMP61-QWERTY-EU-W	146227	BMP61 Label Printer - QWERTY EU with wifi
BMP61	146229	BMP61 Label Printer - QWERTY US
BMP61-QWERTY-EU	146230	BMP61 Label Printer - QWERTY EU
BMP61-AZERTY-EU-W	146231	BMP61 Label Printer - AZERTY with wifi
BMP61-QWERTZ-EU	148637	BMP61 Label Printer - QWERTZ
BMP61-AZERTY-EU	148638	BMP61 Label Printer - AZERTY
BMP61-QWERTY-UK	196453	BMP61 Label Printer - QWERTY UK
BMP61-QWERTY-UK-W	196454	BMP61 Label Printer - QWERTY UK with wifi
BMP61-CYRILLIC-W	196467	BMP61 Label Printer - CYRILLIC with wifi
BMP61-AZ-EU-W-PWID	198632	BMP61 Label Printer - AZERTY with wifi and Brady Workstation PWID Suite
BMP61-AZ-EU-PWID	198633	BMP61 Label Printer - AZERTY with Brady Workstation PWID Suite
BMP61-CYR-W-PWID	198634	BMP61 Label Printer - CYRILLIC with wifi and Brady Workstation PWID Suite
BMP61-QY-EU-W-PWID	198635	BMP61 Label Printer - QWERTY EU with wifi and Brady Workstation PWID Suite
BMP61-QY-EU-PWID	198636	BMP61 Label Printer - QWERTY EU with Brady Workstation PWID Suite
BMP61-QY-UK-W-PWID	198637	BMP61 Label Printer - QWERTY UK with wifi and Brady Workstation PWID Suite
BMP61-QY-UK-PWID	198638	BMP61 Label Printer - QWERTY UK with Brady Workstation PWID Suite
BMP61-QY-US-W-PWID	198639	BMP61 Label Printer - QWERTY US with wifi and Brady Workstation PWID Suite
BMP61-QY-US-PWID	198640	BMP61 Label Printer - QWERTY US with Brady Workstation PWID Suite
BMP61-QZ-EU-W-PWID	198641	BMP61 Label Printer - QWERTZ EU with wifi and Brady Workstation PWID Suite
BMP61-QZ-EU-PWID	198642	BMP61 Label Printer - QWERTZ EU with Brady Workstation PWID Suite



The Basic Suite is included with every printer, all you need to do is download it. [Workstation.BradyID.com/Free](http://Workstation.BradyID.com/Free)



Quickly identify your products and wires with customised text or graphical labels, using serialised or imported data. [Workstation.BradyID.com/ProductandWire](http://Workstation.BradyID.com/ProductandWire)

## Printer kits

These BMP61 printer kits have been created for everyone active within the Electrical & Teledatcom industries. These interestingly priced portable printer kits come with a practical hard case, including a printer, label materials, a battery and accessories.

Order Reference	Art. No.	Description
BMP61-AZ-ELEC*	198660	BMP61 Label Printer - Electrical kit - AZERTY with wifi
BMP61-CYR-W-ELEC*	198662	BMP61 Label Printer - Electrical kit - CYRILLIC with wifi
BMP61-QY-EU-ELEC*	198664	BMP61 Label Printer - Electrical kit - QWERTY EU with wifi
BMP61-QY-UK-ELEC*	198666	BMP61 Label Printer - Electrical kit - QWERTY UK with wifi
BMP61-QZ-EU-ELEC*	198668	BMP61 Label Printer - Electrical kit - QWERTZ with wifi
BMP61-AZ-DATA**	198659	BMP61 Label Printer - Voice- and Datacom kit - AZERTY with wifi
BMP61-CYR-W-DATA**	198661	BMP61 Label Printer - Voice- and Datacom kit - CYRILLIC with wifi
BMP61-QY-EU-DATA**	198663	BMP61 Label Printer - Voice- and Datacom kit - QWERTY EU with wifi
BMP61-QY-UK-DATA**	198665	BMP61 Label Printer - Voice- and Datacom kit - QWERTY UK with wifi
BMP61-QZ-EU-DATA**	198667	BMP61 Label Printer - Voice- and Datacom kit - QWERTZ with wifi

\*This printer ships in a hard case holding a USB cable, a quick start guide, a battery pack, an AC Adapter, a driver CD, a product CD, a hand strap, a Magnet accessory, a Brady Workstation Product & Wire Identification Suite, a roll of PTL-19-423, PTL-21-427, PTL-31-499, PSPT-187-1-YL, an M61-R4310 and an M61-R6010 ribbon.

\*\*This printer ships in a hard case holding a USB cable, a quick start guide, a battery pack, an AC Adapter, a CD with driver, a product CD, a hand strap, a Brady Workstation Product & Wire Identification Suite, a roll of PTL-19-423, PTL-31-427, PTL-8-422, PTL-12-109, an M61-R4310 and an M61-R6010 ribbon.

## Accessories



Magnet



Strap



Art. No.	Description
710612	AC Adaptor - Europe 220V
710613	AC Adaptor - UK 240V
114883	AC Adaptor - USA 120V
146220	Hard Case for BMP61
146221	Magnet for BMP61
018556	Printer cleaning kit
133255	Rechargeable NIMH Battery
146233	Strap for BMP61
103788	USB Cable

## Printers

Order Reference	Art. No.	Description
M611-EU-BT-W	149570	M611 Label Printer - EU
M611-EU-PWIDS	199974	M611 Label Printer - EU with Brady Workstation PWID Suite
M611-UK-BT-W	199973	M611 Label Printer - UK
M611-UK-PWIDS	199975	M611 Label Printer - UK with Brady Workstation PWID Suite
M611-AM-BT-W	149569	M611 Label Printer - US
M611-US-PWIDS	199976	M611 Label Printer - US with Brady Workstation PWID Suite

 The Basic Suite is included with every printer, all you need to do is download it.  
[Workstation.BradyID.com/Free](http://Workstation.BradyID.com/Free)

 Quickly identify your products and wires with customised text or graphical labels, using serialised or imported data.  
[Workstation.BradyID.com/ProductandWire](http://Workstation.BradyID.com/ProductandWire)



 For more information on the Express app, see page 55.

## Accessories

Art. No.	Description
710612	AC Adaptor - Europe 220V
710613	AC Adaptor - UK 240V
114883	AC Adaptor - USA 120V
149568	Carrying bag for M611
149567	Hard case for M611
149566	Magnet for M611
018556	Printer cleaning kit
146233	Strap for M611/BMP61



Magnet



Hard case



Carrying bag

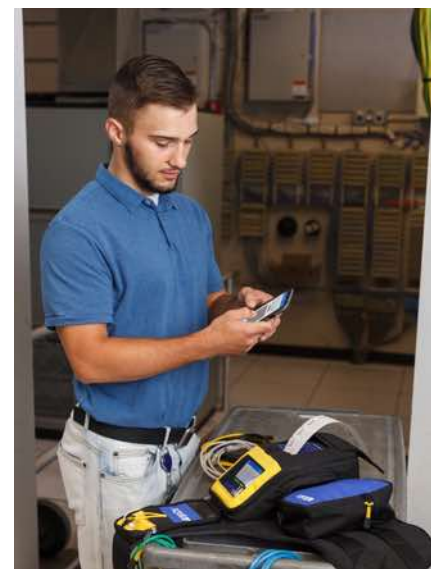

**Africa**

Randburg, South Africa  
 Tel.: +27 11 704 3295  
 Email: africa@bradycorp.com

**Benelux**

Zele, Belgium  
 Tel.: +32 (0) 52 45 78 11  
 Email: benelux@bradycorp.com

**Central & Eastern Europe**

Bratislava, Slovakia  
 Tel.: +421 2 3300 4800  
 Email: central\_europe@bradycorp.com

**Denmark**

Odense  
 Tel.: +45 66 14 44 00  
 Email: denmark@bradycorp.com

**France**

Roncq  
 Tel.: +33 (0) 3 20 76 94 48  
 Email: france@bradycorp.com

**Germany, Austria & Switzerland**

Egelsbach, Germany  
 Tel.: +49 (0) 6103 7598 660  
 Email: germany@bradycorp.com

**Hungary**

Budaörs  
 Tel.: +36 23 500 275  
 Email: central\_europe@bradycorp.com

**Italy**

Gorgonzola  
 Tel.: +39 02 26 00 00 22  
 Email: italy@bradycorp.com

**Middle East FZE**

Dubai, UAE  
 Tel.: +971 4881 2524  
 Email: me@bradycorp.com

**Norway**

Kjeller  
 Tel.: +47 70 13 40 00  
 Email: norway@bradycorp.com

**Romania**

Bucharest  
 Tel.: +40 21 202 3032  
 Email: central\_europe@bradycorp.com

**Russia**

Moscow  
 Tel.: +7 495 269 47 87  
 Email: central\_europe@bradycorp.com

**Spain & Portugal**

Madrid, Spain  
 Tel.: +34 900 902 993  
 Email: spain@bradycorp.com,  
 portugal@bradycorp.com

**Sweden, Finland, Baltic states**

Kista, Sweden  
 Tel.: +46 (0) 8 590 057 30  
 Email: sweden@bradyeurope.com

**Turkey**

Istanbul  
 Tel.: +90 212 264 02 20 / 264 02 21  
 Email: turkey@bradycorp.com

**UK & Ireland**

Banbury, UK  
 Tel.: +44 (0) 1295 228 288  
 Email: uk@bradycorp.com

# Our mission is to identify and protect people, products and places



To help minimise our impact on the environment, Brady limits its number of reprints.

Updated versions are always available for download on [www.bradyeurope.com](http://www.bradyeurope.com).

 Search for: EUR-M-835-EN



Y4273387

Your distributor

04/11/2019